



BNC Series Coaxial Connectors

2003 ONLINE CATALOG

Contents

CLICK ON ANY LINE TO GO DIRECTLY TO THE INDICATED PAGE

Navigation Guide	2
Specifications and interface dimensions.	3
Design Features	4

Cable Connectors

Straight Cable Plugs	7
Right Angle Cable Plugs.	9
Straight Cable Jacks	11
Bulkhead Cable Jacks	12
Panel Cable Jacks	14

Receptacles

Panel Jack Receptacles	16
Right Angle Panel Jack Receptacles	17
Panel Plug Receptacles.	17
Bulkhead Jack Receptacles	18
Bulkhead Plug Receptacles.	19
P.C. Board Receptacles	20
Stripline Receptacles	20
PressMount Receptacles.	21

Accessories

Resistive Terminations	22
Dust Caps.	22
In-Series Adapters	23
BNC75 (75Ω impedance)	
Cable Connectors.	25
Receptacles	26
In-Series Adapters	27

Technical Information

Mounting Figures	28
Cable Groups.	29
Cable Assembly Instructions	30
Assembly Tooling.	33
Ordering and Warranty	34

We have configured this online catalog to take advantage of Acrobat navigation shortcuts (links). However, these links are not visible on the pages— making them visible would compromise the page’s readability.

- Clicking on any entry in the Table of Contents will take you to the indicated page.
- Shown below are the “hot spots” on all of the product pages that will take you to background information on various connector characteristics.
- After you use a link to jump to another page, you can use the “back” arrow in Acrobat’s menu bar to return to the page you jumped from.
- Configure Acrobat Reader to show bookmarks for a table of contents by specific characteristic (for example, cable plugs broken out by cable attachment method).
- To find a specific part number, use Acrobat’s search feature.

In addition, the pages are formatted to fit within the margins of standard laser or inkjet printers—no need to use the “shrink to fit” option when printing pages from Acrobat.

Click [here](#) to go to the Table of Contents

Click on the Delta logo on any page to jump to the table of contents.

Click on the page title to jump to specifications and interface dimensions.

BNC Cable Jacks

Panel Jack—Military Clamp for Flexible Cable

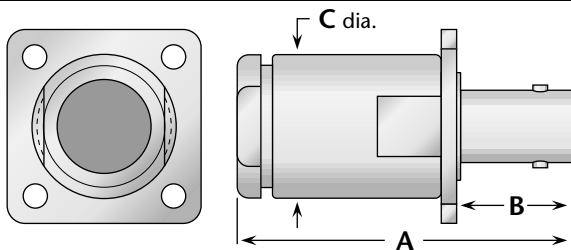

Figure 1

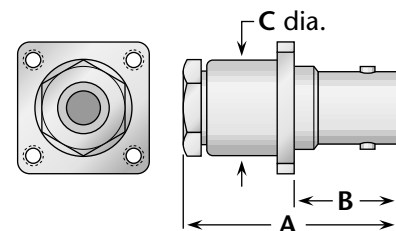

Figure 2

Cable Group	Fig.	Dimensions			Mounting Figure	Plating		Delta P/N	Assembly Procedure/Trim Code
		A	B	C		Body	Contact		
1	1	1.75	.63	.75	33	Nickel	Silver	1011-001-N330	A/20
2, 3	1	1.75	.63	.75	33	Nickel	Silver	1011-004-N330	A/20
5, 6	2	1.16	.55	.50	07	Nickel	Silver	UG-291C/U	A/17

Click here to jump to dimensions for Delta mounting figures.

Click here to jump to the cable assembly procedure for this connector.

Click here to jump to a guide to Delta cable groups.

Click here to go to Delta’s website if your computer is configured for Web connection via Acrobat.

General Description

Delta BNC connectors are compact, economical, 50Ω impedance connectors with two-stud bayonet coupling. They are best suited for use with cables in the range of .150" to .250" diameter, but are available for other cables from .090" to over .75" diameter. M39012 QPL BNC connectors and M55339 QPL BNC adapters are also included in this section.

Our extensive line of BNC receptacles includes configurations for virtually any packaging requirement, and we can supply any adapter or accessory you may need to complete your system design. As with our other connector series, Delta's *customer-driven design* results in BNC series connectors with practical and unique features that make your design and assembly process easier. Some of these include:

- *Heli-Grip* cable connectors for fast, reliable assembly to flexible cable without special tooling.
- *PressMount* receptacles (page 21) mount securely in a single round hole, saving space on your components and reducing your housing fabrication costs.
- Panel receptacles with flange sizes to match the same hole pattern as standard SMA or type N connectors, letting you drill one hole pattern and mount BNC, N, SMA, TNC, or 7/16 series connectors as needed.
- Isolated ground receptacles (see page 19).
- 75Ω impedance BNC connectors (see page 25) for matched-impedance applications.

Our BNC series product line is still growing, so please call if you don't see what you need.

For adapters between BNC and other series, download the document *DeltaABS.pdf* from our website.

BNC Specifications*

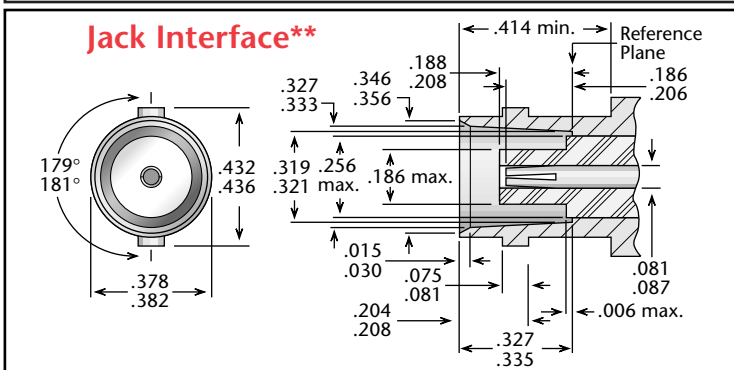
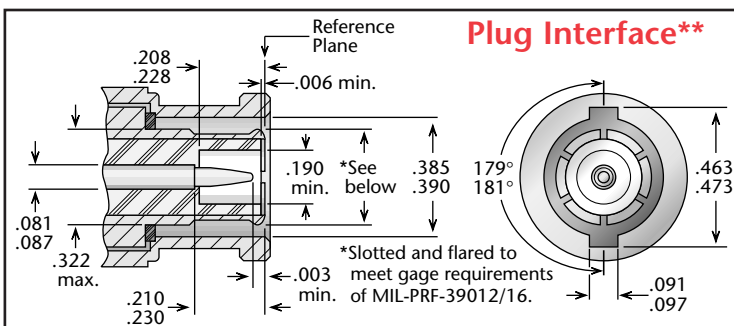

Electrical:

Nominal Impedance: 50 ohms.
Frequency Range: DC-4 GHz.
Voltage Rating: 500 volts RMS.
Dielectric Withstanding Voltage: 1,500 VRMS.
Insulation Resistance: 5,000 megohms.

Materials/Finishes:

Insulators: Teflon per ASTM-D-1710.
Male Contacts: Brass per ASTM-B-16.
Female Contacts: Beryllium Copper per ASTM-B-196.
Contact Plating: Silver per QQ-S-365, or Gold per MIL-G-45204.

Gaskets: Silicone rubber per ZZ-R-765, Class II, Grade 50.

Other Metal Parts: Brass per ASTM-B-16, plated:
 Silver per QQ-S-365, or
 Nickel per QQ-N-290.

All other specifications are in accordance with the latest issues of MIL-PRF-39012, or MIL-A-55339, or other applicable MIL specifications, and interfaces are in accordance with MIL-STD-348.

*These specifications are typical and may not apply to all connectors. Detailed specifications for individual connectors are available on request.

**Some proportions altered to illustrate detail.

About Delta's Customer-Driven Design

At Delta, *Customer-Driven Design* isn't just a catchy slogan. It means that we make RF connectors that help you build your products efficiently, quickly, and cost-effectively. Because we design for *your* needs, nobody else can offer you such a broad line of standard connectors, along with an ever-growing list of innovative, user-friendly design variations like those detailed on these pages.

These featured connector technologies grew out of real-world requirements, and have saved our customers untold hours and dollars over the years. And there are thousands of other special connector designs we've produced that we don't have space to include in this catalog. So if you don't see the exact connector configuration you need, please call us—we may have already made it. If not, we'll work with you to provide the the connectors you need, with the best price/performance balance in the business, and with quality and delivery that will enhance your products and production schedules.

Design Features

Plating options.....	4
Panel receptacles with common flange sizes	5
PressMount receptacles.....	6
Heli-Grip connectors for flexible cable	6

Plating Options for Economy and Performance

(Albaloy or nickel—available for all connector series except SMA)

Silver plating has long been standard on RF connectors with brass bodies, but its high cost and low corrosion resistance make it less than ideal in most applications. Nickel plating is less expensive and more durable than silver, and is standard on many of our connectors.

However, in some applications, nickel plating can introduce unwanted intermodulation distortion, particularly on large size connectors. For these applications, we offer optional Albaloy plating, a tin/zinc/copper composite with a bright white finish, the corrosion resistance of nickel, and the low intermodulation distortion of silver plating.

Albaloy plating has the same composition as, and is fully compatible with, other commercial platings designated Sucoplate[®], IP-23, White Bronze, and Tri-Alloy.

To order a Delta connector with plating other than the listed finish, substitute **A**, **N**, or **Q** in the Delta part number as below:

For **silver** plating: 1111-111-**A**111.

For **nickel** plating: 1111-111-**N**111.

For **Albaloy** plating: 1111-111-**Q**111.

Note: M39012 and M55339 QPL connectors can only be supplied with the specified plating. SMA connectors with stainless-steel bodies are available with gold plating or passivated finish.

Common Flange Sizes Simplify Your Production

(Available on BNC, N, SMA, TNC, and 7/16 series connectors as noted in product pages)

Does it make sense that you have to drill your components with different mounting hole patterns whenever you need to ship them with a different connector series attached? We didn't think so, either.

That's why we offer a wide range of connectors in different series with common flange sizes and contact/insulator configurations. Now you can streamline your production process and shorten your delivery cycle—just predrill your components with one mounting hole pattern, and ship them with the connectors your customers require.

Flange Sizes and Available Interfaces

1/2" square flange (Delta mounting figure 05)—standard flange size for SMA

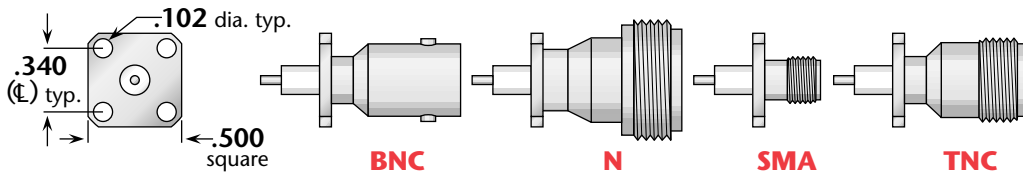

11/16" square flange (Delta mounting figure 09)—standard flange size for BNC, TNC

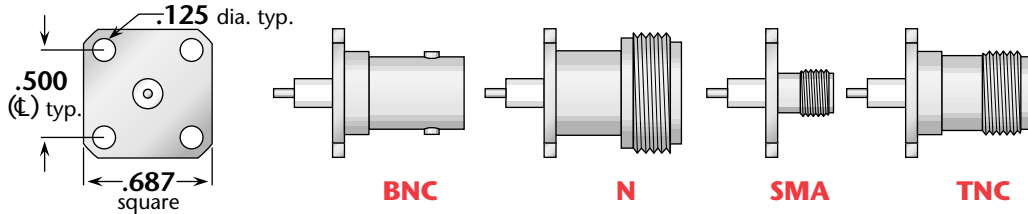

1" square flange (Delta mounting figure 33)—standard flange size for type N

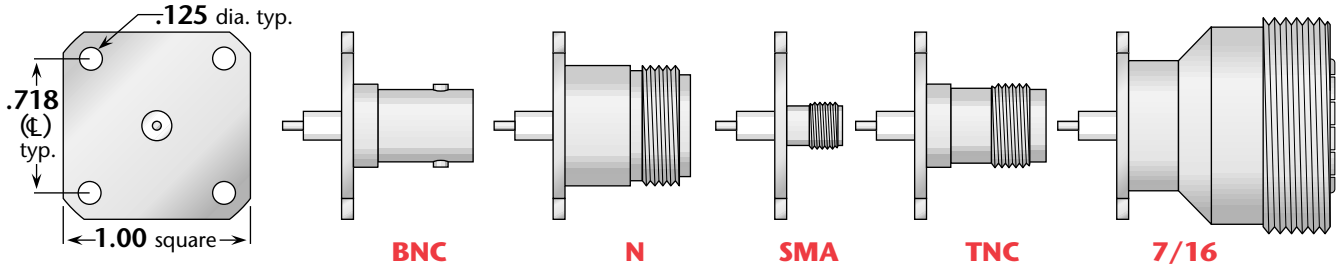

Contact and insulator configurations are shown for illustration only—these connectors are available with a wide variety of post, tab, solder pot, or slotted contacts. Standard configurations are shown on product pages, and your request for a custom design is always welcome.

Delta PressMount Receptacles

Connector design

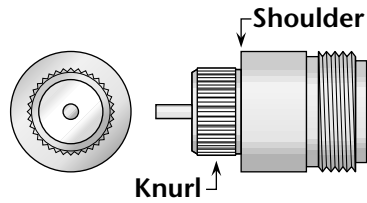

As mounted on component

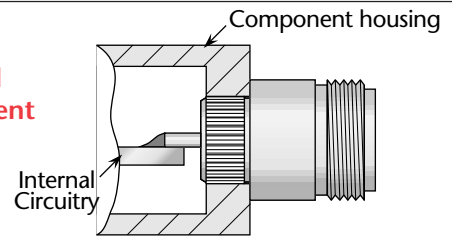

Delta PressMount receptacles eliminate the need for complicated mounting hole patterns and mounting hardware. They are simply pressed into a single through hole, and can be used in component housings as small as the outer diameter of the connector. An integral shoulder provides a positive depth stop during mounting.

Besides the standard types shown below and in the product pages, PressMount receptacles are available with a wide variety of contact and insulator configurations—please call if you don't see what you need.

Standard BNC PressMount Receptacles

BNC jack
(Solder pot or post contact—page 21)

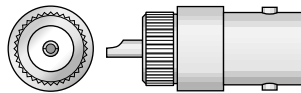

BNC plug
(Post contact—page 21)

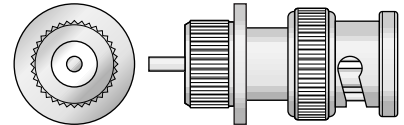

Heli-Grip® Cable Attachment—for Flexible Cable

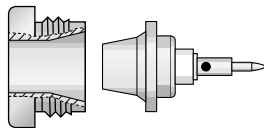

Backnut; cone/contact/insulator subassembly

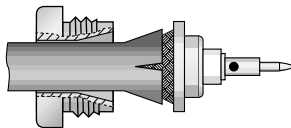

Cable assembled to hardware subassembly

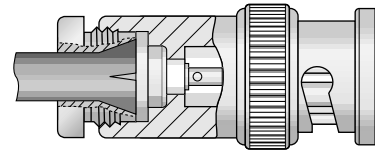

(Proportions altered to illustrate detail)
As assembled in connector

With their reduced parts count and rapid assembly, Delta's Heli-Grip connectors offer you significant time savings in your cable assembly operation, without the need for dedicated crimp tools.

Heli-Grip connectors all have captivated contacts, and assembly is easy—simply trim the cable, slide the trimmed cable into the cone/insulator/contact assembly (left), solder the center conductor to the contact, and screw the body assembly (right) onto the backend assembly.

Heli-Grip connectors have cable retention strength greater than the force required to tear the cable braid.

Standard BNC Heli-Grip Configurations

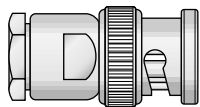

Straight plug—page 8

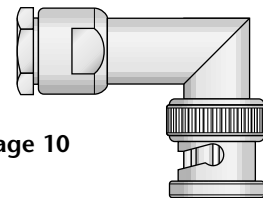

Right angle plug—page 10

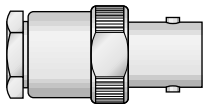

Straight jack—page 11

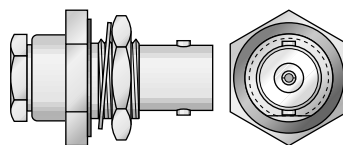

Bulkhead jack—page 13

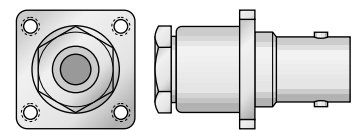

Panel jack—page 15

Straight Plug—Military Clamp for Flexible Cable

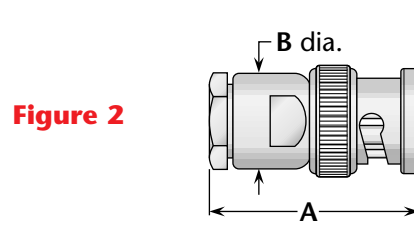
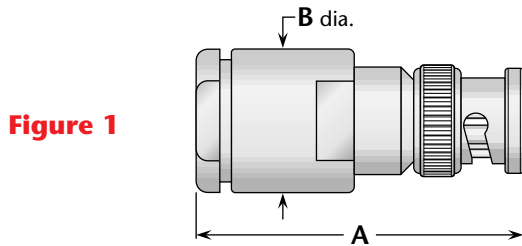

Cable Group	Figure	Dimensions		Plating		Delta P/N	Assembly Procedure/ Trim Code
		A	B	Body	Contact		
1	1	1.16	.56	Nickel	Silver	1001-001-N000-1	C/06
2, 3	1	1.66	.75	Nickel	Silver	UG-959A/U	A/01
2, 3	1	1.66	.75	Silver	Gold (C)	M39012/16-0225	A/01
5, 6	2	1.03	.44	Nickel	Silver	UG-88/U	C/04
5, 6	2	1.06	.50	Nickel	Silver	UG-88C/U	A/17
5, 6	2	1.06	.50	Nickel	Silver	UG-88E/U	A/17
5, 6	2	1.06	.50	Nickel	Gold (C)	1001-015-N001	A/17
5, 6	2	1.06	.50	Silver	Gold (C)	M39012/16-0101	A/17
7	2	1.03	.44	Nickel	Silver	UG-260/U	C/04
7	2	1.06	.50	Nickel	Silver	UG-260B/U	A/17
7	2	1.06	.50	Nickel	Silver	UG-260D/U	A/17
7	2	1.06	.50	Nickel	Silver (C)	1001-021-N001	A/17
7	2	1.06	.50	Silver	Gold (C)	M39012/16-0102	A/17
8A	2	1.06	.50	Nickel	Silver	UG-1033C/U	A/17
8A	2	1.06	.50	Nickel	Silver (C)	1001-029-N001	A/17
8A	2	1.06	.50	Silver	Gold (C)	M39012/16-0103	A/17
8B	2	1.06	.50	Nickel	Silver	1001-043-N000	A/17
8B	2	1.06	.50	Nickel	Silver (C)	1001-043-N001	A/17
9	2	1.06	.50	Nickel	Silver	1001-036-N000	A/18
9	2	1.06	.50	Nickel	Silver (C)	1001-036-N001	A/18
9	2	1.06	.50	Silver	Gold (C)	M39012/16-0220	A/37
11	2	1.06	.50	Nickel	Silver	1001-038-N000	A/18
22	2	1.06	.50	Silver	Gold (C)	M39012/16-0118	A/17
23	2	1.06	.50	Silver	Gold (C)	M39012/16-0111	A/17
25	2	1.06	.50	Nickel	Silver	1001-132-N000	A/17

Straight Plug—Solder-Clamp for Semi-Rigid Cable

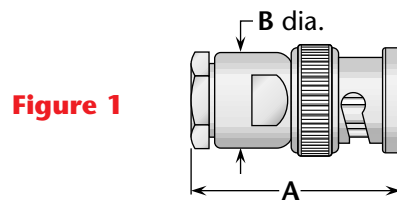

Cable Group	Figure	Dimensions		Plating		Delta P/N	Assembly Procedure/ Trim Code
		A	B	Body	Contact		
13	1	1.06	.50	Nickel*	Silver	1001-031-N003	F/08
14	1	1.06	.50	Nickel*	Silver	1001-025-N003	F/07

* Solder ferrule is gold plated.

(C) in contact plating column indicates captive contact.

Straight Plug—Heli-Grip® for Flexible Cable

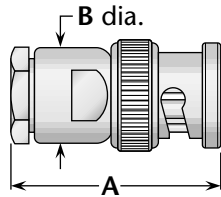
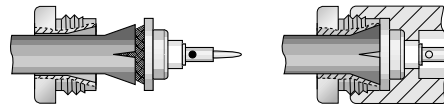

Figure 1

Heli-Grip® Cable Attachment



These connectors have captivated contacts and allow rapid, easy assembly—simply trim the cable, slide into the cone/insulator/contact assembly (left), solder the center conductor to the contact, and screw body assembly (right) onto cable assembly.

Cable Group	Figure	Dimensions		Plating		Delta P/N	Assembly Procedure/ Trim Code
		A	B	Body	Contact		
5, 6 [§]	1	1.06	.50	Nickel	Silver (C)	1001-018-N005	E/03
RG-223	1	1.06	.50	Nickel	Silver (C)	1001-015-N005-3	E/03
7	1	1.06	.50	Nickel	Silver (C)	1001-019-N005	E/03
8A	1	1.06	.50	Nickel	Silver (C)	1001-029-N005-1	E/03
8B	1	1.06	.50	Nickel	Silver (C)	1001-043-N005	E/03
9	1	1.06	.50	Nickel	Silver (C)	1001-037-N005	E/03
10	1	1.06	.50	Nickel	Silver (C)	1001-100-N005	E/03
11	1	1.06	.50	Nickel	Silver (C)	1001-038-N005	E/03

[§]Except RG-223/U.

Straight Plug—Crimp Type for Flexible Cable

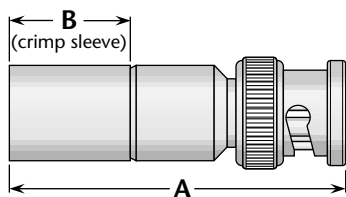

Figure 1

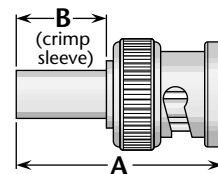

Figure 2

Cable Group	Figure	Dimensions		Plating		Delta P/N	Assembly Procedure/ Trim Code
		A	B	Body	Contact		
3A, 4	1	1.72	.63	Nickel	Gold (C)	1003-005-N000	B/11
5	2	1.09	.50	Nickel	Gold	1003-017-N000	B/18
5	2	1.10	.50	Nickel	Gold (C)	1003-017-N00E-2	B/19
6	2	1.09	.50	Nickel	Gold	1003-013-N000	B/18
6	2	1.10	.50	Nickel	Gold (C)	1003-013-N00E	B/19
7	2	1.09	.50	Nickel	Gold	1003-020-N000-2	B/18
7	2	1.10	.50	Nickel	Gold (C)	1003-019-N00E-2	B/19
7	2	1.05	.41	Nickel	Silver	1003-020-N000-5*	***
7	2	1.05	.41	Nickel	Gold	1003-020-N000-6*	***
7	2	1.05	.50	Nickel	Silver (C)	1003-020-N001-5*	***
7	2	1.05	.50	Nickel	Gold (C)	1003-020-N001-9*	***
9	2	.94	.31	Nickel	Silver (C)	1003-037-N000	B/20

* Crimp center contact.

(C) in contact plating column indicates captive contact. • ***Contact factory for cable assembly instructions.

Right Angle Plug—Military Clamp for Flexible Cable

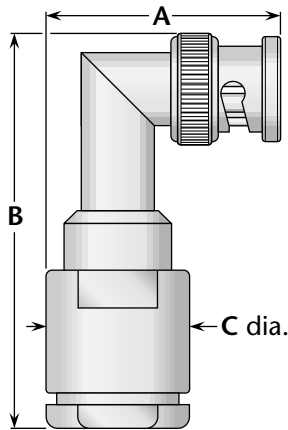

Figure 1

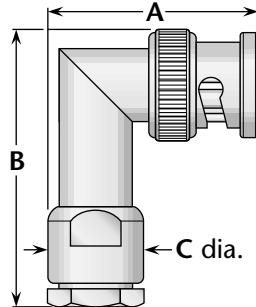

Figure 2

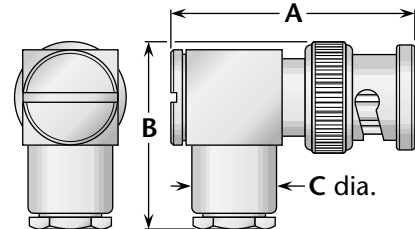

Figure 3

Cable Group	Figure	Dimensions			Plating		Delta P/N	Assembly Procedure/ Trim Code
		A	B	C	Body	Contact		
1	1	1.23	1.92	.75	Nickel	Gold	1004-001-N000	A/07
2, 3	1	1.23	1.92	.75	Nickel	Silver	1004-004-N000	A/07
5, 6	2	1.09	1.61	.50	Nickel	Silver	UG-913/U	A/17
5, 6	2	1.09	1.61	.50	Nickel	Silver	UG-913A/U	A/17
5, 6	2	1.09	1.61	.50	Nickel	Silver (C)	1004-015-N001	A/17
5, 6	2	1.09	1.61	.50	Silver	Gold (C)	M39012/20-0101	A/17
5, 6	3	1.25	1.06	.44	Nickel	Silver (C)	1005-014-N000	C/05
7	2	1.09	1.61	.50	Nickel	Silver	1004-021-N000	A/17
7	2	1.09	1.61	.50	Nickel	Silver (C)	1004-021-N001	A/17
7	2	1.09	1.61	.50	Silver	Gold (C)	M39012/20-0102	A/17
7	3	1.25	1.06	.44	Nickel	Silver (C)	1005-021-N000-1	C/05
8A	3	1.25	1.06	.44	Nickel	Silver (C)	1005-029-N000	C/05
8B	2	1.09	1.61	.50	Nickel	Silver	1004-043-N000	A/17
9	2	1.09	1.61	.50	Nickel	Silver	1004-036-N000	A/18
9	3	1.25	1.06	.44	Nickel	Silver (C)	1005-036-N000	C/05
22	2	1.09	1.61	.50	Silver	Gold (C)	M39012/20-0108	A/17

Right Angle Plug—Solder-Clamp for Semi-Rigid Cable

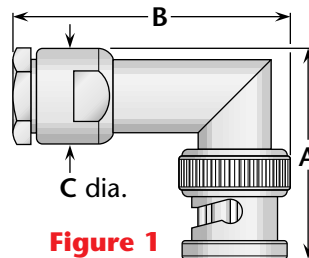

Figure 1

Cable Group	Figure	Dimensions			Plating		Delta P/N	Assembly Procedure/ Trim Code
		A	B	C	Body	Contact		
13	1	1.09	1.61	.50	Nickel*	Silver	1004-031-N003	F/08
14	1	1.09	1.61	.50	Nickel*	Silver	1004-025-N003	F/07

* Solder ferrule is gold plated.

(C) in contact plating column indicates captive contact.

Right Angle Plug—Heli-Grip® for Flexible Cable

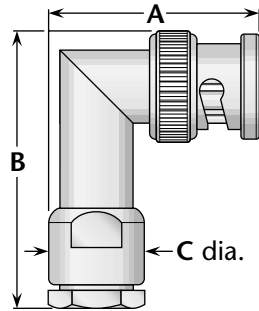
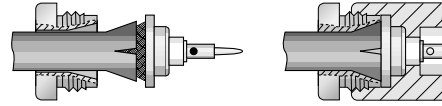

Figure 1

Heli-Grip® Cable Attachment



These connectors have captivated contacts and allow rapid, easy assembly—simply trim the cable, slide into the cone/insulator/contact assembly (left), solder the center conductor to the contact, and screw body assembly (right) onto cable assembly.

Cable Group	Figure	Dimensions			Plating		Delta P/N	Assembly Procedure/ Trim Code
		A	B	C	Body	Contact		
5, 6 [§]	1	1.09	1.61	.50	Nickel	Silver (C)	1004-018-N005	E/03
RG-223	1	1.09	1.61	.50	Nickel	Silver (C)	1004-015-N005	E/03
7	1	1.09	1.61	.50	Nickel	Silver (C)	1004-019-N005	E/03
8A	1	1.09	1.61	.50	Nickel	Silver (C)	1004-029-N005	E/03
8B	1	1.09	1.61	.50	Nickel	Silver (C)	1004-043-N005	E/03
9	1	1.09	1.61	.50	Nickel	Silver (C)	1004-037-N005	E/03
10	1	1.09	1.61	.50	Nickel	Silver (C)	1004-100-N005	E/03
11	1	1.09	1.61	.50	Nickel	Silver (C)	1004-038-N005	E/03

§Except RG-223/U.

Right Angle Plug—Crimp Type for Flexible Cable

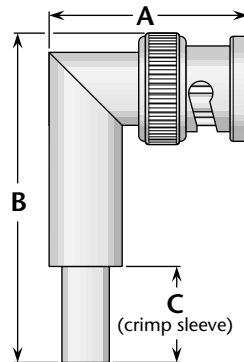

Figure 1

Cable Group	Figure	Dimensions			Plating		Delta P/N	Assembly Procedure/ Trim Code
		A	B	C	Body	Contact		
5	1	1.03	1.71	.50	Nickel	Gold (C)	1007-017-N000-3	B/02
6	1	1.03	1.71	.50	Nickel	Silver	1007-015-N000	B/02
7	1	1.03	1.71	.50	Nickel	Gold	1007-019-N000-1	B/02

(C) in contact plating column indicates captive contact.

Straight Jacks—For Flexible and Semi-Rigid Cable

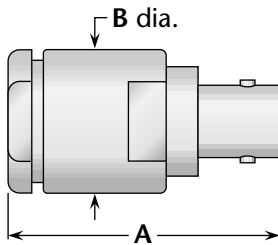

Figure 1

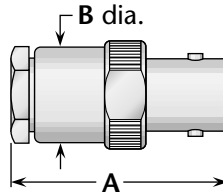

Figure 2

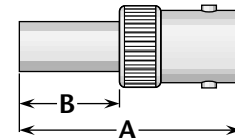

Figure 3

Military Clamp for Flexible Cable

Cable Group	Figure	Dimensions		Plating		Delta P/N	Assembly Procedure/ Trim Code
		A	B	Body	Contact		
2, 3	1	1.75	.75	Nickel	Silver	1008-004-N000	A/20
5, 6	2	1.16	.50	Nickel	Silver	UG-89C/U	A/17
5, 6	2	1.16	.50	Nickel	Gold (C)	1008-015-N001	A/17
5, 6	2	1.16	.50	Silver	Gold (C)	M39012/17-0101	A/17
7	2	1.16	.50	Nickel	Silver	UG-261C/U	A/17
7	2	1.16	.50	Nickel	Silver (C)	1008-021-N001	A/17
7	2	1.16	.50	Silver	Gold (C)	M39012/17-0102	A/17
8A	2	1.16	.50	Silver	Gold (C)	M39012/17-0103	A/17
9	2	1.16	.50	Nickel	Silver	1008-036-N000	A/18
9	2	1.16	.50	Nickel	Silver (C)	1008-036-N001	A/18
11	2	1.16	.50	Nickel	Silver	1008-038-N000	A/18
22	2	1.16	.50	Silver	Gold (C)	M39012/17-0118	A/17
23	2	1.16	.50	Silver	Gold (C)	M39012/17-0111	A/17

Heli-Grip for Flexible Cable

5, 6 [§]	2	1.16	.50	Nickel	Silver (C)	1008-018-N005-1	E/03
RG-223	2	1.16	.50	Nickel	Silver (C)	1008-015-N005	E/03
7	2	1.16	.50	Nickel	Silver (C)	1008-019-N005	E/03
8A	2	1.16	.50	Nickel	Silver (C)	1008-029-N005	E/03
8B	2	1.16	.50	Nickel	Silver (C)	1008-043-N005	E/03
9	2	1.16	.50	Nickel	Silver (C)	1008-037-N005	E/03
10	2	1.16	.50	Nickel	Silver (C)	1008-100-N005	E/03
11	2	1.16	.50	Nickel	Silver (C)	1008-038-N005-2	E/03

Crimp Type for Flexible Cable

5	3	1.16	.50	Nickel	Gold	1010-017-N000-1	B/05
6	3	1.16	.50	Nickel	Gold	1010-013-N000	B/05
7	3	1.16	.50	Nickel	Gold	1010-020-N000	B/05
7	3	1.06	.41	Nickel	Silver	1010-020-N001-1**	***

Solder-Clamp for Semi-Rigid Cable

13	2	1.16	.50	Nickel*	Silver	1008-031-N003	F/08
14	2	1.16	.50	Nickel*	Silver	1008-025-N003	F/07

[§]Except RG-223/U.

*Solder ferrule is gold plated.

(C) in contact plating column indicates captive contact. • **Indicates crimp center contact. • ***Contact factory for cable assembly instructions.

Bulkhead Jacks—Military Clamp for Flexible Cable

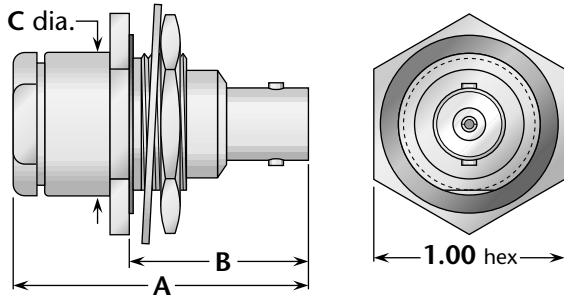

Figure 1
(Rear mount)

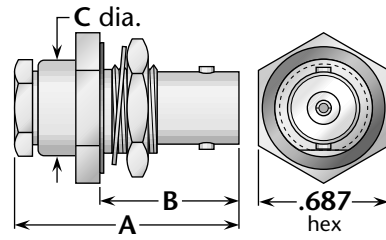

Figure 2
(Rear mount)

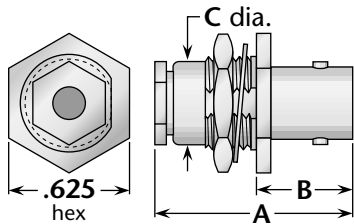

Figure 3
(Front mount)

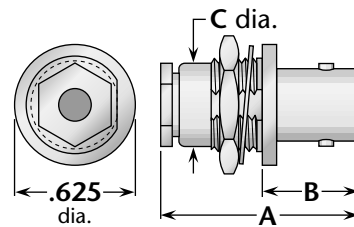

Figure 4
(Front mount)

Cable Group	Fig.	Dimensions			Mounting Figure	Max. Panel	Plating		Delta P/N	Assembly Procedure/Trim Code
		A	B	C			Body	Contact		
2, 3	1	1.55	.92	.75	51	.11	Nickel	Gold (C)	1016-004-N511	A/20
5, 6	2	1.16	.68	.50	59	.11	Nickel	Silver	UG-909/U	A/17
5, 6	2	1.16	.68	.50	59	.11	Nickel	Silver	UG-909A/U	A/17
5, 6	2	1.16	.81	.50	59	.24	Nickel	Silver	UG-909B/U	A/17
5, 6	2	1.16	.81	.50	59	.24	Silver	Gold (C)	M39012/19-0101	A/17
5, 6	2	1.16	.68	.50	59	.11	Nickel	Gold (C)	1016-015-N591	A/17
5, 6	3	1.14	.55	.44	57	.09	Nickel	Silver	1017-014-N570	C/04
7	2	1.16	.68	.50	59	.11	Nickel	Silver	UG-910/U	A/17
7	2	1.16	.68	.50	59	.11	Nickel	Silver	UG-910A/U	A/17
7	2	1.16	.81	.50	59	.24	Nickel	Silver	UG-910B/U	A/17
7	2	1.16	.81	.50	59	.24	Silver	Gold (C)	M39012/19-0102	A/17
7	2	1.16	.68	.50	59	.11	Nickel	Silver (C)	1016-021-N591	A/17
7	4	1.14	.55	.44	57	.09	Nickel	Silver	UG-624/U	C/04
8A	2	1.16	.81	.50	59	.24	Silver	Gold (C)	M39012/19-0110	A/17
9	2	1.16	.68	.50	59	.11	Nickel	Silver	1016-036-N590	A/18
9	2	1.16	.68	.50	59	.11	Nickel	Silver (C)	1016-036-N591	A/17
9	2	1.16	.81	.50	59	.24	Silver	Gold (C)	M39012/19-0220	A/17
11	2	1.16	.68	.50	59	.11	Nickel	Silver	1016-038-N590	A/18
11	2	1.16	.68	.50	59	.11	Nickel	Silver (C)	1016-038-N591	A/18
22	2	1.16	.81	.50	59	.24	Silver	Gold (C)	M39012/19-0118	A/17
23	2	1.16	.81	.50	59	.24	Silver	Gold (C)	M39012/19-0111	A/17

(C) in contact plating column indicates captive contact.

Bulkhead Jack—Heli-Grip® for Flexible Cable

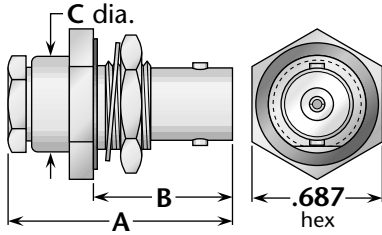
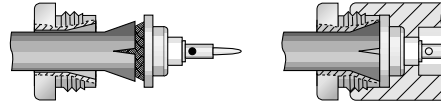

Figure 1 (Rear mount)

Heli-Grip® Cable Attachment



These connectors have captivated contacts and allow rapid, easy assembly—simply trim the cable, slide into the cone/insulator/contact assembly (left), solder the center conductor to the contact, and screw body assembly (right) onto cable assembly.

Cable Group	Fig.	Dimensions			Mounting Figure	Max. Panel	Plating		Delta P/N	Assembly Procedure/Trim Code
		A	B	C			Body	Contact		
5, 6 [§]	1	1.16	.81	.50	59	.24	Nickel	Silver (C)	1016-018-N595	E/03
RG-223	1	1.16	.81	.50	59	.24	Nickel	Silver (C)	1016-015-N595	E/03
7	1	1.16	.81	.50	59	.24	Nickel	Silver (C)	1016-019-N595	E/03
8A	1	1.16	.81	.50	59	.24	Nickel	Silver (C)	1016-029-N595	E/03
8B	1	1.16	.81	.50	59	.24	Nickel	Silver (C)	1016-043-N595	E/03
9	1	1.16	.81	.50	59	.24	Nickel	Silver (C)	1016-037-N595	E/03
10	1	1.16	.81	.50	59	.24	Nickel	Silver (C)	1016-100-N595-2	E/03
11	1	1.16	.81	.50	59	.24	Nickel	Silver (C)	1016-038-N595-2	E/03

[§]Except RG-223/U.

Bulkhead Jack—Crimp Type for Flexible Cable

Figure 1 (Rear mount)

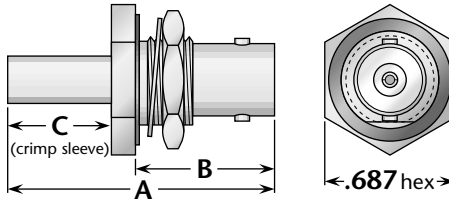

Cable Group	Fig.	Dimensions			Mounting Figure	Max. Panel	Plating		Delta P/N	Assembly Procedure/Trim Code
		A	B	C			Body	Contact		
5	1	1.31	.68	.50	59	.11	Nickel	Silver	1019-016-N590	B/21
6	1	1.31	.68	.50	59	.11	Nickel	Silver	1019-013-N590	B/21
7	1	1.31	.68	.50	59	.11	Nickel	Silver	1019-020-N590	B/22

Bulkhead Jack—Solder-Clamp for Semi-Rigid Cable

Figure 1 (Rear mount)

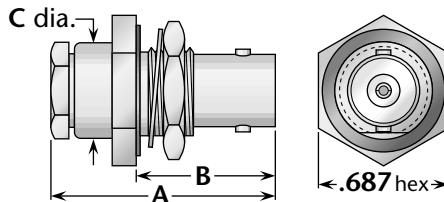

Cable Group	Fig.	Dimensions			Mounting Figure	Max. Panel	Plating		Delta P/N	Assembly Procedure/Trim Code
		A	B	C			Body	Contact		
13	1	1.16	.81	.50	59	.24	Nickel*	Silver	1016-031-N593	F/08
14	1	1.16	.81	.50	59	.24	Nickel*	Silver	1016-025-N593	F/07

* Solder ferrule is gold plated.

(C) in contact plating column indicates captive contact.

Panel Jack—Military Clamp for Flexible Cable

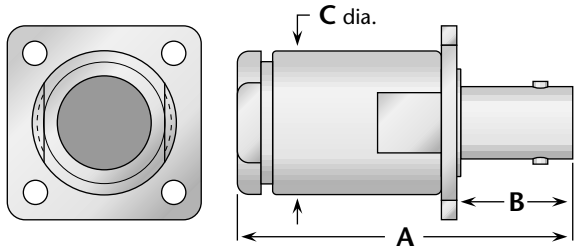

Figure 1

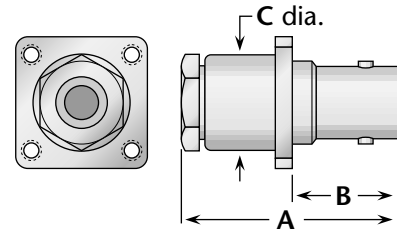

Figure 2

Cable Group	Fig.	Dimensions			Mounting Figure	Plating		Delta P/N	Assembly Procedure/Trim Code
		A	B	C		Body	Contact		
1	1	1.75	.63	.75	33	Nickel	Silver	1011-001-N330	A/20
2, 3	1	1.75	.63	.75	33	Nickel	Silver	1011-004-N330	A/20
5, 6	2	1.16	.55	.50	07	Nickel	Silver	UG-291C/U	A/17
5, 6	2	1.16	.55	.50	07	Silver	Gold (C)	M39012/18-0102	A/17
5, 6	2	1.16	.55	.50	07	Nickel	Gold (C)	1011-015-N071	A/17
7	2	1.16	.55	.50	07	Nickel	Silver	UG-262C/U	A/17
7	2	1.16	.55	.50	07	Silver	Gold (C)	M39012/18-0101	A/17
7	2	1.16	.55	.50	07	Nickel	Silver (C)	1011-021-N071	A/17
8A	2	1.16	.55	.50	07	Silver	Gold (C)	M39012/18-0103	A/17
9	2	1.16	.55	.50	07	Nickel	Silver	1011-036-N070	A/18
9	2	1.16	.55	.50	07	Nickel	Silver (C)	1011-036-N071	A/38
9	2	1.16	.55	.50	07	Silver	Gold (C)	M39012/18-0220	A/38
11	2	1.16	.55	.50	07	Nickel	Silver	1011-038-N070	A/18
11	2	1.16	.55	.50	07	Nickel	Silver (C)	1011-038-N071	A/18
22	2	1.16	.55	.50	07	Silver	Gold (C)	M39012/18-0118	A/17
23	2	1.16	.55	.50	07	Silver	Gold (C)	M39012/18-0111	A/17

Panel Jack—Solder-Clamp for Semi-Rigid Cable

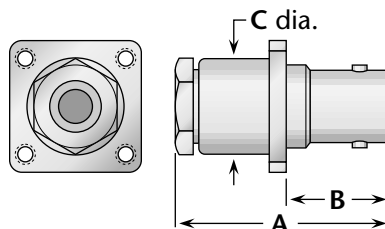

Figure 1

Cable Group	Fig.	Dimensions			Mounting Figure	Plating		Delta P/N	Assembly Procedure/Trim Code
		A	B	C		Body	Contact		
13	1	1.16	.55	.50	07	Nickel*	Gold	1011-031-N073	F/08
14	1	1.16	.55	.50	07	Nickel*	Gold	1011-025-N073	F/07

* Solder ferrule is gold plated.

(C) in contact plating column indicates captive contact.

Panel Jack—Heli-Grip® for Flexible Cable

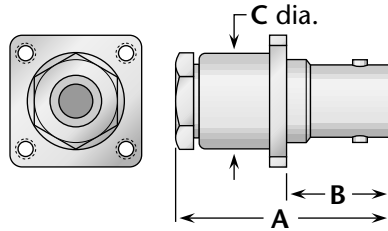
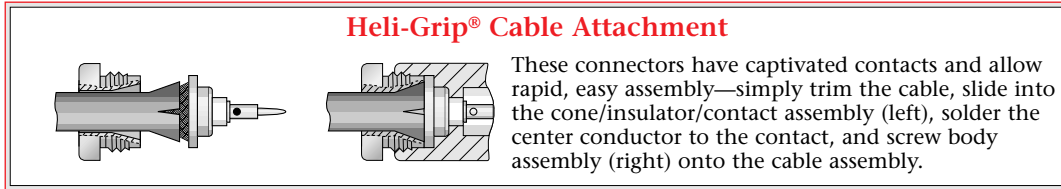

Figure 1

Cable Group	Fig.	Dimensions			Mounting Figure	Plating		Delta P/N	Assembly Procedure/Trim Code
		A	B	C		Body	Contact		
5, 6 [§]	1	1.16	.55	.50	07	Nickel	Silver (C)	1011-018-N075	E/03
RG-223	1	1.16	.55	.50	07	Nickel	Silver (C)	1011-015-N075	E/03
7	1	1.16	.55	.50	07	Nickel	Silver (C)	1011-019-N075	E/03
8A	1	1.16	.55	.50	07	Nickel	Silver (C)	1011-029-N075	E/03
8B	1	1.16	.55	.50	07	Nickel	Silver (C)	1011-043-N075	E/03
9	1	1.16	.55	.50	07	Nickel	Silver (C)	1011-037-N075	E/03
10	1	1.16	.55	.50	07	Nickel	Silver (C)	1011-100-N075	E/03
11	1	1.16	.55	.50	07	Nickel	Silver (C)	1011-038-N075	E/03

§Except RG-223/U.

Panel Jack—Crimp Type for Flexible Cable

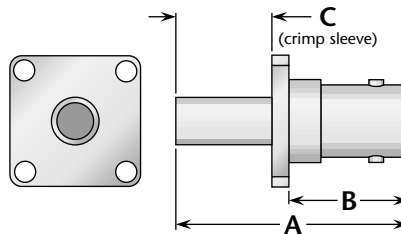

Figure 1

Cable Group	Fig.	Dimensions			Mounting Figure	Plating		Delta P/N	Assembly Procedure/Trim Code
		A	B	C		Body	Contact		
5	1	1.22	.63	.50	09	Nickel	Gold (C)	1055-017-N091	B/12
6	1	1.22	.63	.50	09	Nickel	Gold (C)	1055-015-N091	B/12
7	1	1.22	.63	.50	09	Nickel	Gold (C)	1055-019-N091	B/12

(C) in contact plating column indicates captive contact.

Panel Jack Receptacles—Square Flange

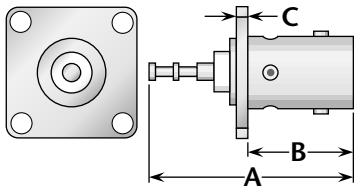

Figure 1
(Turret contact)

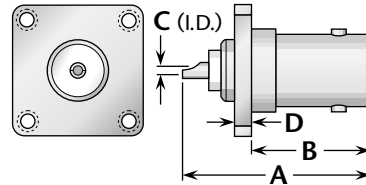

Figure 2
(Solder pot contact)

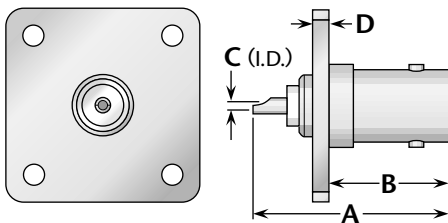

Figure 3
(Solder pot contact, 1" square flange,
interchangeable with type N standard flange size)

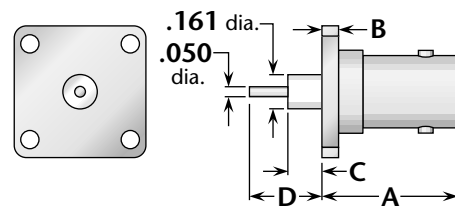

Figure 4
(Post contact)

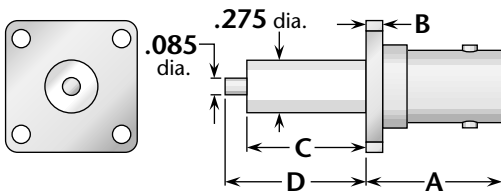

Figure 5
(Post contact)

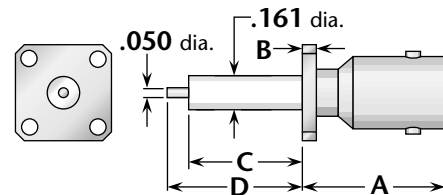

Figure 6
(Post contact, 1/2" square flange,
interchangeable with SMA standard flange size)

Figure	Dimensions				Mounting Figure	Plating		Delta P/N
	A	B	C	D		Body	Contact	
1	1.06	.55	.050	—	18	Nickel	Silver (C)	UG-185/U
2	1.06	.63	.062	.090	07	Nickel	Silver (C)	UG-290A/U
2	1.06	.63	.043	.090	12	Nickel	Silver (C)	UG-447/U
2	1.06	.63	.062	.090	07	Silver	Gold (C)	M39012/22-0001
2	1.06	.63	.062	.090	09	Nickel	Silver (C)	1013-000-N090
2	1.06	.63	.062	.090	10	Nickel	Silver (C)	1013-000-N100
2	1.06	.63	.062	.090	18	Nickel	Gold (C)	1013-000-N180
2	1.00	.75	.062	.080	18 [§]	Nickel	Gold (C)	1013-000-F181**
3	1.06	.63	.062	.080	33	Nickel	Silver (C)	1013-000-N330
4	.715	.090	.175	.375	09	Nickel	Silver (C)	1058-000-N091
5	.750	.080	.590	.705	18 [§]	Nickel	Gold (C)*	1058-000-N181-1
6	.750	.080	.590	.705	05	Nickel	Gold (C)	1058-000-N051

(C) in contact plating column indicates captive contact. • *Indicates epoxy-captivated contact. • **Insulator flush with rear of flange.
[§]Flange #18 except with .125 dia. mounting holes. • See page 4 for alternate body plating information.

Right Angle Panel Jack Receptacle—Square Flange

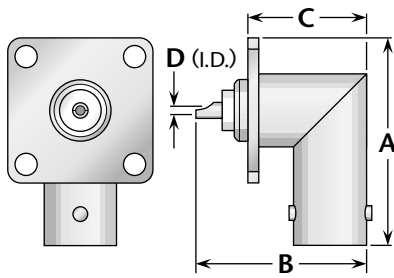

Figure 1
(Solder pot contact)

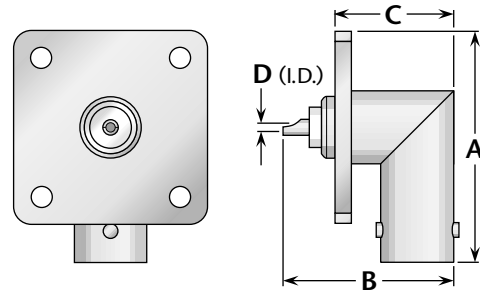

Figure 2
(Solder pot contact, 1" square flange, interchangeable with type N standard flange size)

Figure	Dimensions				Mounting Figure	Plating		Delta P/N
	A	B	C	D		Body	Contact	
1	1.09	.91	.61	.062	18	Nickel	Silver (C)	UG-535/U
1	1.06	.91	.65	.062	07	Nickel	Silver (C)	1015-000-N070
1	1.06	.91	.65	.062	09	Nickel	Gold (C)	1015-000-N090
2	1.22	.91	.61	.062	33	Nickel	Silver (C)	1015-000-N330

Panel Plug Receptacle—Square Flange

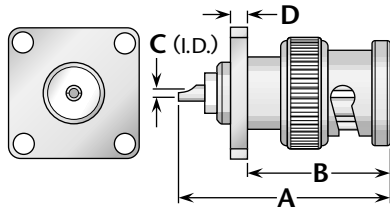

Figure 1
(Solder pot contact, 3/4" square flange)

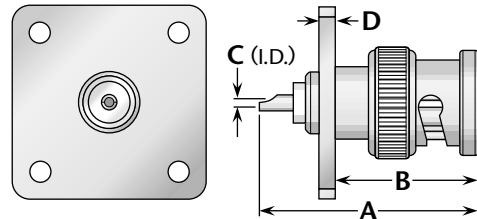
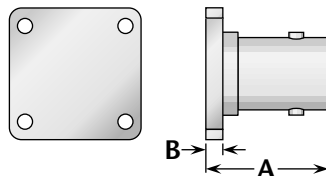

Figure 2
(Solder pot contact, 1" square flange, interchangeable with type N standard flange size)

Figure	Dimensions				Mounting Figure	Plating		Delta P/N
	A	B	C	D		Body	Contact	
1	1.19	.80	.062	.090	18	Nickel	Silver (C)	UG-1104A/U
2	1.19	.80	.062	.080	33	Nickel	Silver (C)	1023-000-N330

Dummy Receptacle



Dimensions		Mounting Figure	Plating		Delta P/N
A	B		Body	Contact	
.75	.090	09	Nickel	—	1063-000-N090

(C) in contact plating column indicates captive contact.

Bulkhead Jack Receptacles

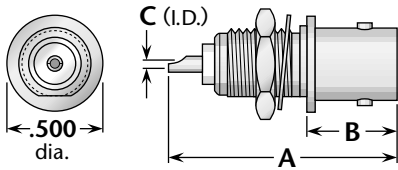

Figure 1
(Front mount)

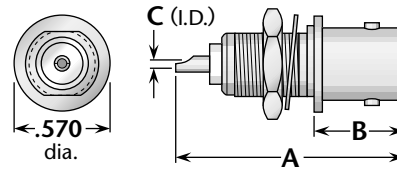

Figure 2
(Front mount, pressurized [non-hermetic], with mounting gasket)

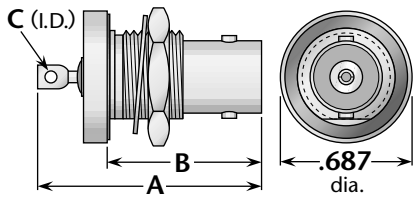

Figure 3
(Rear mount, hermetically sealed, with mounting gasket)

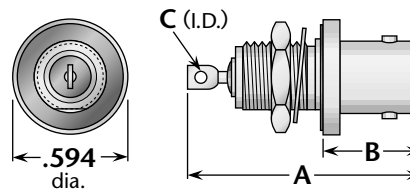

Figure 4
(Front mount, hermetically sealed, with mounting gasket)

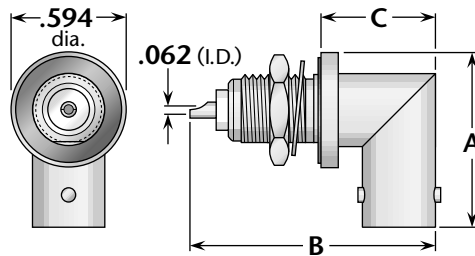

Figure 5
(Right angle, solder pot contact)

Figure	Dimensions			Max. Panel	Mounting Figure	Plating		Delta P/N
	A	B	C			Body	Contact	
1	1.06	.49	.062	.13	62	Nickel	Silver (C)	UG-625B/U
2	1.28	.60	.052	.19	75	Nickel	Silver (C)	UG-657/U
2	1.28	.60	.052	.19	75	Nickel	Silver (C)	UG-657A/U
1	1.06	.47	.062	.13	65	Nickel	Silver (C)	UG-1094/U
1	1.19	.47	.062	.26	65	Nickel	Silver (C)	UG-1094A/U
1	1.06	.49	.062	.13	62	Silver	Gold (C)	M39012/21-0001
1	1.19	.47	.062	.26	65	Silver	Gold (C)	M39012/21-0002
1	1.19	.47	.062	.26	62	Silver	Gold (C)	M39012/21-0003
3	1.20	.83	.062	.26	59	Nickel	Silver (C)	UG-911A/U
3	1.20	.83	.062	.26	59	Silver	Gold (C)	M39012/24-0001
4	1.20	.52	.062	.26	63	Nickel	Silver (C)	UG-912/U
4	1.33	.52	.062	.34	63	Nickel	Silver (C)	UG-912A/U
4	1.20	.52	.062	.26	63	Silver	Gold (C)	M39012/24-0002
5	.92	1.22	.59	.13	63	Nickel	Silver (C)	UG-1098/U
5	.92	1.34	.59	.25	63	Nickel	Silver (C)	UG-1098A/U
5	.92	1.22	.59	.13	62	Nickel	Silver (C)	UG-1174/U

(C) in contact plating column indicates captive contact.

Bulkhead Jack Receptacles with Solder Lug

Figure 1
(Standard grounding)

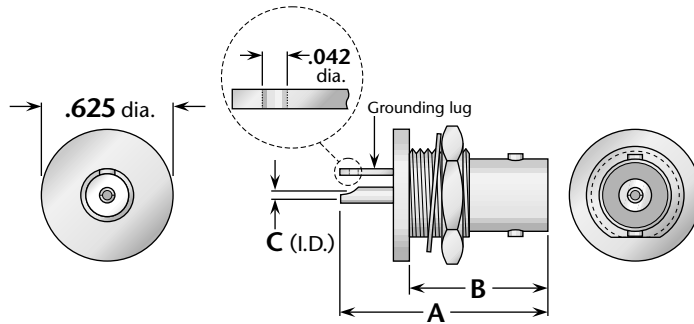

Isolated-Ground Receptacles

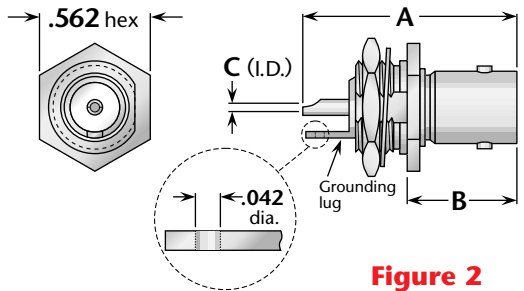
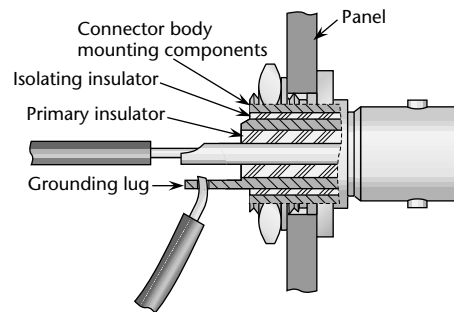

Figure 2
(Isolated ground)



These receptacles feature an additional insulator between the main connector body and the body's mounting surfaces, electrically isolating the ground signal of the circuit from the panel. The circuit ground signal is passed through the panel via the solder lug for termination inside the equipment. Since they are not a triaxial connector design, isolated-ground receptacles can be used with any standard BNC plugs.

Figure	Dimensions			Max. Panel	Mounting Figure	Plating		Delta P/N
	A	B	C			Body	Contact	
1	1.06	.75	.062	.17	59	Nickel	Gold (C)	1021-000-N591
2	1.06	.50	.062	.17	59	Nickel	Gold (C)	1020-000-F59G

Bulkhead Plug Receptacle

Figure 1
(Front mount)

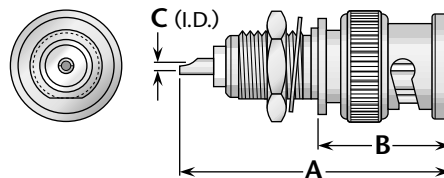

Figure	Dimensions			Max. Panel	Mounting Figure	Plating		Delta P/N
	A	B	C			Body	Contact	
1	1.25	.69	.062	.16	65	Nickel	Silver (C)	1024-000-N651

(C) in contact plating column indicates captive contact.

Receptacles for Printed Circuit Boards

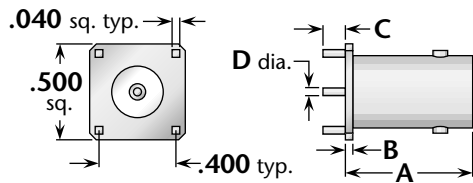
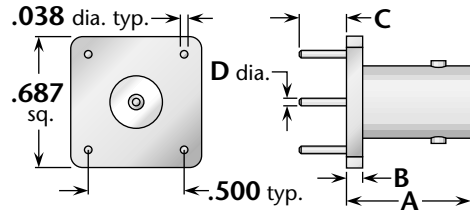
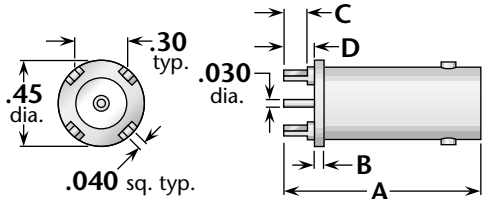
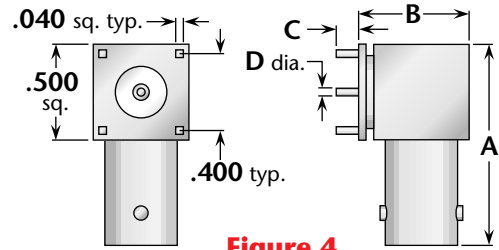
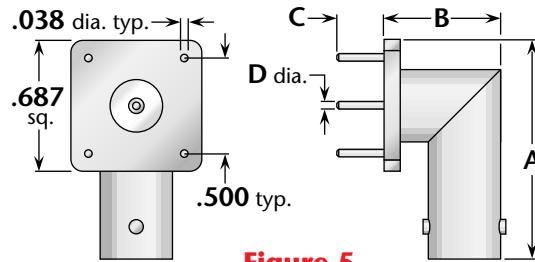

Figure 1

Figure 2

Figure 3

Figure 4

Figure 5

Figure	Dimensions				Max. Board Thickness	Mounting Figure	Plating		Delta P/N
	A	B	C	D			Body	Contact	
1	.66	.040	.116	.040	.063	PCB01	Nickel	Gold (C)	1058-000-N04P
1	1.27	.040	.116	.040	.063	PCB01	Nickel	Gold (C)	1058-000-N04P-1
2	.65	.085	.250	.038	.125	PCB02	Nickel	Gold (C)	1058-000-N13P
3	1.03	.050	.125	.160	.063	PCB03	Nickel	Silver (C)	1067-000-N91P-1
4	1.06	.575	.116	.040	.063	PCB01	Nickel	Gold (C)	1069-000-N03P
5	.95	.61	.250	.038	.125	PCB02	Nickel	Gold (C)	1069-000-N13P

Stripline Receptacles

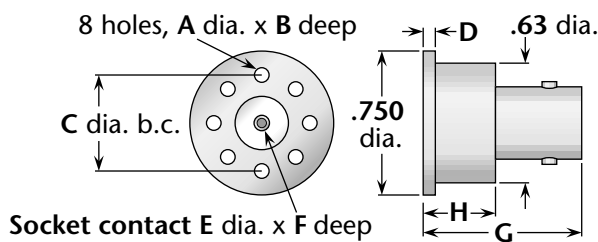
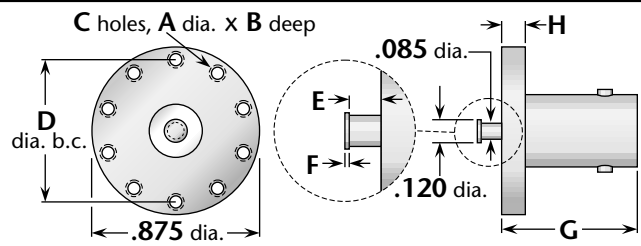
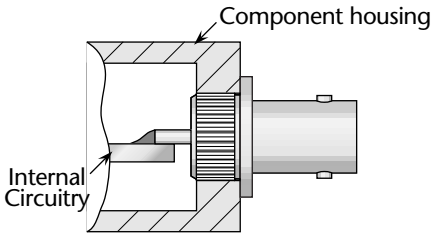

Figure 1

Figure 2

Figure	Dimensions								Plating		Delta P/N
	A	B	C	D	E	F	G	H	Body	Contact	
1	.078	.31	.500	.063	.063	.22	.828	.375	Nickel	Gold (C)	1056-000-N000
2	#2-56	.125	10	.734	.125	.010	.710	.125	Nickel	Gold	1057-000-N000

(C) in contact plating column indicates captive contact.

PressMount Receptacles

Delta PressMount Receptacles



Internal Circuitry

Component housing

These connectors eliminate the need for complicated mounting hole patterns and mounting hardware. They are simply pressed into a single through hole, and the precisely-engineered knurled mounting section provides retention strength far greater than normal mating and unmating forces. An integral shoulder provides a positive stop when mounting.

PressMounts are available for a wide variety of Delta connector series, and can be used in packages as small as the outer diameter of the connector body.

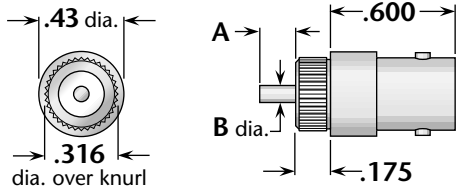

Figure 1
(Post contact)

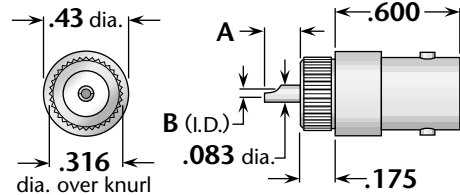

Figure 2
(Solder pot contact)

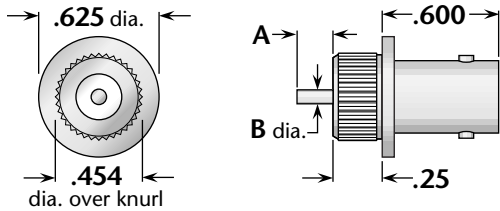

Figure 3
(Post contact)

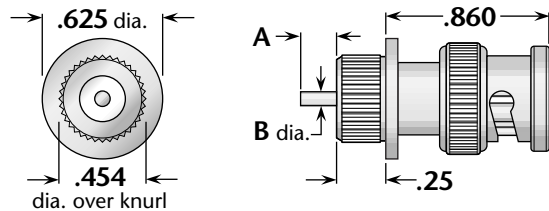
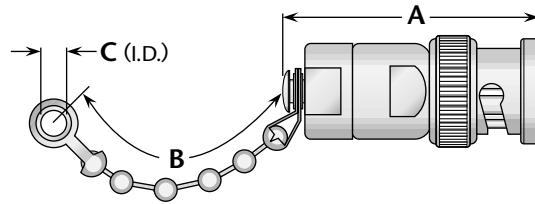

Figure 4
(Plug type, post contact)

Figure	Dimensions		Min. Panel	Mounting Hole	Plating		Delta P/N
	A	B			Body	Contact	
1	.062	.050	.150	.312 ±.001 dia.	Nickel	Silver (C)	1020-000-N911-1
2	.285	.062	.150	.312 ±.001 dia.	Nickel	Silver (C)	1020-000-N911-2
3	.060	.050	.200	.450 ±.001 dia.	Nickel	Gold (C)	1020-000-N911-13
4	.060	.050	.200	.450 ±.001 dia.	Nickel	Gold (C)	1024-000-N911-4

(C) in contact plating column indicates captive contact.

Resistive Termination (Plug Type)



Resistor	Dimensions			Features	Plating		Delta P/N
	A	B	C		Body	Contact	
51Ω ±5%, 1/2 Watt	1.25	3.50	.144		Nickel	Gold (C)	MX-554/U
51Ω ±5%, 1/2 Watt	1.41	3.50	.144		Nickel	Silver (C)	MX-554A/U
51Ω ±5%, 1/2 Watt	1.14	—	—	No chain	Nickel	Gold (C)	1031-000-N00A-3
51Ω ±5%, 1 Watt	1.50	4.50	.130		Nickel	Silver (C)	1051-000-N000
51Ω ±5%, 1 Watt	1.39	—	—	No chain	Nickel	Silver (C)	1051-000-N00A-5
75Ω ±5%, 1/2 Watt	1.41	3.50	.144		Nickel	Silver (C)	1031-000-N000-4
75Ω ±5%, 1/2 Watt	1.14	—	—	No chain	Nickel	Gold (C)	1031-000-N00A-1
75Ω ±5%, 1 Watt	1.39	—	—	No chain	Nickel	Silver (C)	1051-000-N00A-2

Dust Caps

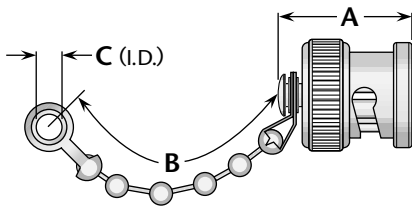

Figure 1
(Shown with bead chain)

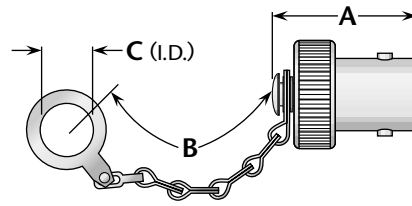
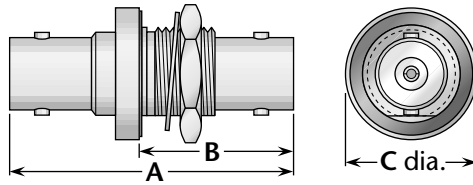

Figure 2
(Shown with safety chain)

Figure	Dimensions			Features	Plating		Delta P/N
	A	B	C		Body	Contact	
1	.67	2.25	.144	Bead chain	Nickel	—	CW-123A/U
1	.59	—	—	No chain	Nickel	—	CW-155A/U
1	.69	2.25	.144	Bead chain / shorting type	Nickel	Silver (C)	CW-159/U
1	.67	2.25	.144	Bead chain	Silver	—	M39012/25-0006
1	.67	2.70	.52	Safety chain	Silver	—	M39012/25-0007
2	.69	3.25	.281	Bead chain	Nickel	—	CW-282/U
2	.69	3.25	.281	Bead chain	Silver	—	M39012/25-0008
2	.69	3.25	.281	Safety chain	Silver	—	M39012/25-0009

(C) in contact plating column indicates captive contact. • See page 4 for alternate body plating information.
Caps and terminations are available with other chain styles and/or resistances.

Bulkhead Jack-Jack Adapter (Connects two plugs)



Dimensions			Max. Panel	Mounting Figure	Plating		Delta P/N
A	B	C			Body	Contact	
1.53	.86	.69	.275	59	Nickel	Silver (C)	UG-492A/U*
1.53	.86	.69	.275	59	Nickel	Silver (C)	UG-492C/U*
1.53	.86	.69	.275	59	Nickel	Silver (C)	UG-492D/U*
1.53	.86	.69	.275	59	Silver	Gold (C)	M55339/13-00492*
1.28	.80	.625	.160	59	Nickel	Silver (C)	1026-000-N591

* Hermetically sealed, with mounting gasket.

Panel Mounted Jack-Jack Adapter (Connects two plugs)

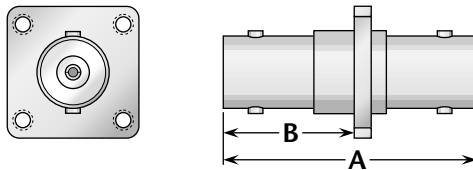

Dimensions		Mounting Figure	Plating		Delta P/N
A	B		Body	Contact	
1.28	.69	07	Nickel	Silver (C)	UG-414A/U

Straight Jack-Jack Adapter (Connects two plugs)

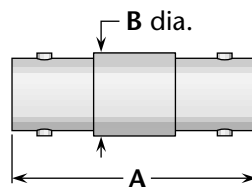

Dimensions		Plating		Delta P/N
A	B	Body	Contact	
1.28	.44	Nickel	Silver (C)	UG-914/U
1.28	.44	Silver	Gold (C)	M55339/16-00914
1.28	.44	Nickel	Gold (C)	1028-000-N001-3

(C) in contact plating column indicates captive contact.

Straight Plug-Plug Adapter (Connects two jacks)

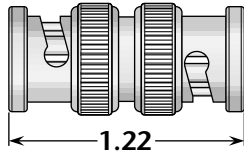

Plating		Delta P/N
Body	Contact	
Nickel	Silver (C)	UG-491B/U
Silver	Gold (C)	M55339/15-00491

Straight Plug-Jack Adapter (Connects one jack and one plug)

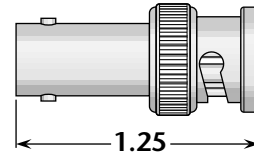

Plating		Delta P/N
Body	Contact	
Nickel	Gold (C)	1034-000-N000

Right Angle and Tee Adapters

Figure 1
(Right angle plug-jack;
connects one plug
and one jack)

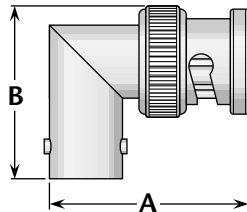

Figure 2
(Tee jack-plug-jack;
connects two plugs
and one jack)

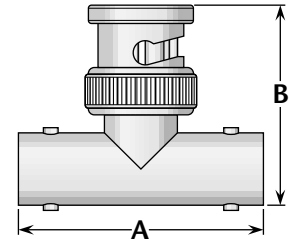

Figure 3
(Tee jack-jack-jack;
connects three plugs)

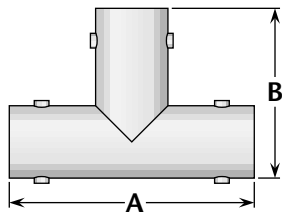

Figure 4
(Tee jack-jack-plug;
connects two plugs
and one jack)

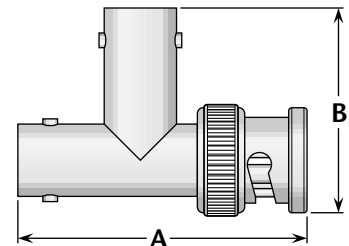

Figure	Dimensions		Plating		Delta P/N
	A	B	Body	Contact	
1	1.06	.88	Nickel	Silver (C)	UG-306A/U
1	1.06	.88	Nickel	Silver (C)	UG-306B/U
1	1.06	.88	Silver	Gold (C)	M55339/14-00306
1	1.06	.88	Nickel	Gold (C)	1029-000-N000-3
2	1.28	1.03	Nickel	Silver (C)	UG-274A/U
2	1.28	1.03	Nickel	Silver (C)	UG-274B/U
2	1.28	1.03	Nickel	Gold (C)	UG-274C/U
2	1.28	1.03	Silver	Gold (C)	M55339/17-00274
3	1.28	.89	Nickel	Silver (C)	1038-000-N000-2
3	1.28	.97	Silver	Gold (C)	M55339/17-00002
4	1.50	1.06	Nickel	Silver (C)	1049-000-N000
4	1.50	1.06	Silver	Gold (C)	M55339/17-00001

(C) in contact plating column indicates captive contact.

Straight and Right Angle Plugs for Flexible Cable

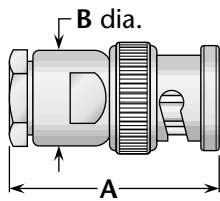

Figure 1
(Heli-Grip® cable hardware)

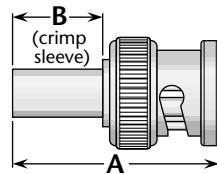

Figure 2
(Crimp type)

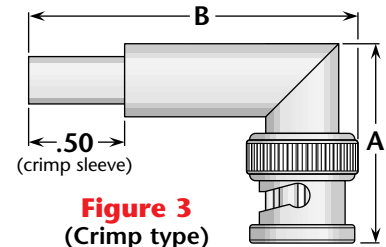
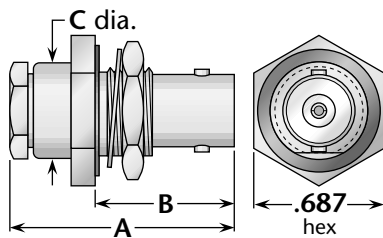

Figure 3
(Crimp type)

Cable Group	Figure	Dimensions		Plating		Delta P/N	Assembly Procedure/ Trim Code
		A	B	Body	Contact		
7	1	1.06	.50	Nickel	Silver (C)	7501-019-N005	E/03
7	2	1.09	.50	Nickel	Gold	7503-020-N000-2	B/19
7	2	1.05	.41	Nickel	Gold (C)	7503-020-N001	B/26
7	3	1.03	1.71	Nickel	Gold	7507-019-N000	B/02
9	1	1.06	.50	Nickel	Silver (C)	7501-037-N005	E/03
9	2	1.13	.39	Nickel	Gold	7503-037-N001	B/27
9	3	1.03	1.71	Nickel	Gold	7507-037-N000	B/02
26	2	1.10	.45	Nickel	Gold (C)	7503-108-N001	B/26
31	2	1.13	.50	Nickel	Gold	7503-279-N001	B/19

Bulkhead Jack—Heli-Grip® for Flexible Cable

Figure 1
(Rear mount)



Heli-Grip® Cable Attachment

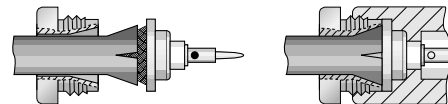

These connectors have captivated contacts and allow rapid, easy assembly—simply trim the cable, slide into the cone/insulator/contact assembly (left), solder the center conductor to the contact, and screw body assembly (right) onto cable assembly.

Cable Group	Fig.	Dimensions			Mounting Figure	Max. Panel	Plating		Delta P/N	Assembly Procedure/ Trim Code
		A	B	C			Body	Contact		
7	1	1.16	.81	.50	59	.24	Nickel	Gold (C)	7516-019-N595	E/03
9	1	1.16	.81	.50	59	.24	Nickel	Gold (C)	7516-037-N595	E/03

(C) in contact plating column indicates captive contact.

Panel Jack and Plug Receptacles—Square Flange

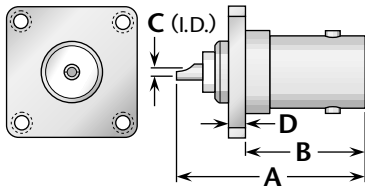

Figure 1
(Solder pot contact, 11/16" square flange)

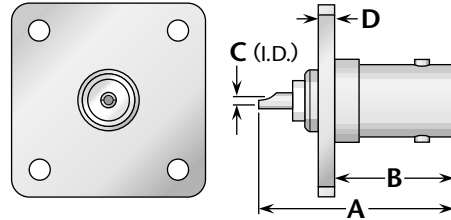

Figure 2
(Solder pot contact, 1" square flange, interchangeable with type N standard flange size)

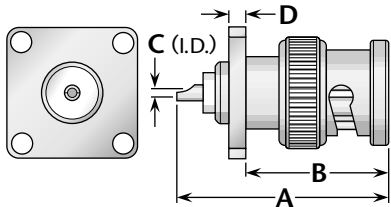

Figure 3
(Solder pot contact, 3/4" square flange)

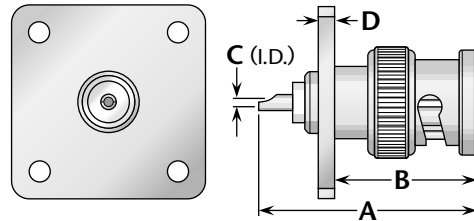

Figure 4
(Solder pot contact, 1" square flange, interchangeable with type N standard flange size)

Figure	Dimensions				Mounting Figure	Plating		Delta P/N
	A	B	C	D		Body	Contact	
1	1.06	.63	.030	.090	09	Nickel	Gold (C)	7513-000-N091
2	1.06	.63	.030	.080	33	Nickel	Gold (C)	7513-000-N331-2
3	1.19	.80	.030	.090	18	Nickel	Gold (C)	7523-000-N180
4	1.19	.80	.030	.080	33	Nickel	Gold (C)	7523-000-N331-1

Receptacles for Printed Circuit Boards

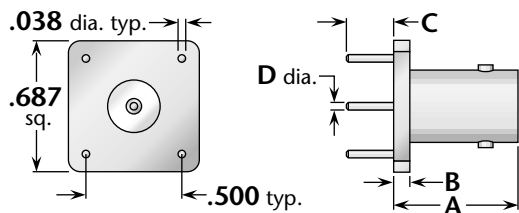

Figure 1

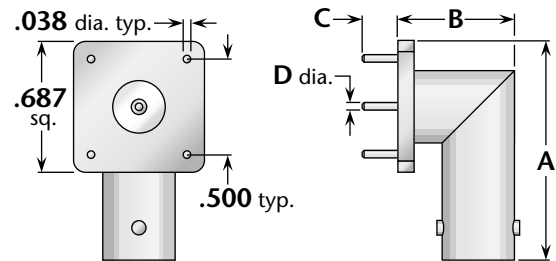

Figure 2

Figure	Dimensions				Max. Board Thickness	Mounting Figure	Plating		Delta P/N
	A	B	C	D			Body	Contact	
1	.65	.085	.250	.038	.125	PCB02	Nickel	Gold (C)	7567-000-N13P-1
2	1.34	.52	.125	.038	.063	PCB02	Nickel	Silver (C)	7569-000-N13P

(C) in contact plating column indicates captive contact.

Bulkhead Jack Receptacle

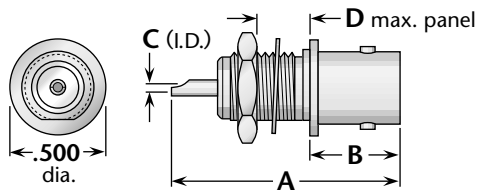

Figure 1
(D-hole mounting)

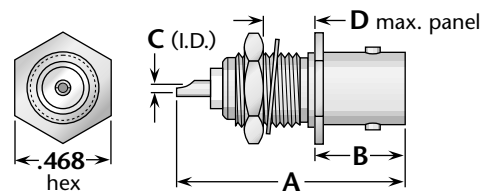
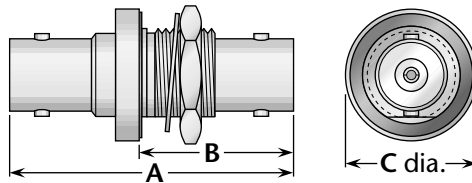

Figure 2
(Round hole mounting)

Figure	Dimensions				Mounting Figure	Plating		Delta P/N
	A	B	C	D		Body	Contact	
1	1.06	.57	.030	.13	65	Nickel	Gold (C)	7520-000-N651-1
2	1.06	.47	.030	.13	89	Nickel	Gold (C)	7521-000-N621-2

Bulkhead Jack-Jack Adapter (Connects two plugs)



Dimensions			Max. Panel	Mounting Figure	Plating		Delta P/N
A	B	C			Body	Contact	
1.28	.80	.625	.16	59	Nickel	Silver (C)	7526-000-N591*
1.28	.80	.625	.16	59	Nickel	Silver (C)	7526-000-N591-1

Straight and Right Angle Adapters

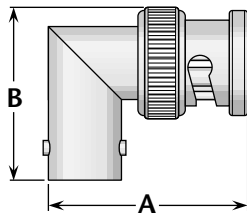

Figure 1
(Right angle plug-jack;
connects one plug and one jack)

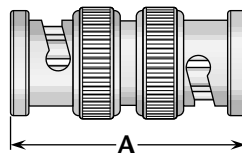

Figure 2
(Straight plug-plug;
connects two jacks)

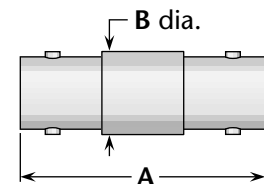
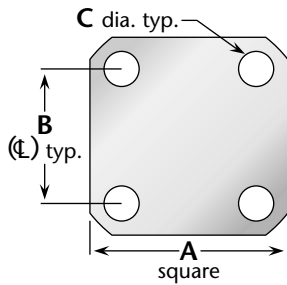

Figure 3
(Straight jack-jack;
connects two plugs)

Figure	Dimensions		Plating		Delta P/N
	A	B	Body	Contact	
1	1.06	.88	Nickel	Gold (C)	7529-000-N000
2	1.22	—	Nickel	Gold (C)	7527-000-N001
3	1.28	.44	Nickel	Gold (C)	7528-000-N001

(C) in contact plating column indicates captive contact. • *Isolated ground mounting.

Connector Flanges (Panel mounted connectors)



4-hole flanges

Figure	A	B	C
04	1/2	.360	.089
05	1/2	.340	.102
07	11/16	.500	#3-56 tap
08	11/16	.500	.136
09	11/16	.500	.125
10	11/16	.500	.120
12	11/16	.500	.109
18	3/4	.531	.136
26	1	.718	#6-32 tap
27	1	.718	#4-40 tap
30	1	.718	.166
32	1	.718	.136
32A	1	.718	.136*
33	1	.718	.125
34	13/32	.812	.150
36	13/16	.906	#6-32 tap
39	13/16	.906	.152
40	13/16	.906	.125
45	2	1.437	.257
91	.375	.250	.067
91A	.375	.232	.093

* Countersunk to .245 dia.

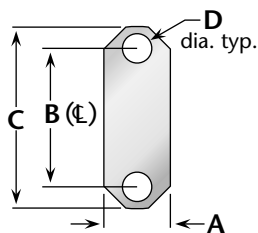

2-hole flanges

Figure	A	B	C	D
92	.223	.481	.625	.102
92A	.260	.481	.625	.102
95	.640	1.015	1.30	.125

Panel Cutouts (Bulkhead mounted connectors)

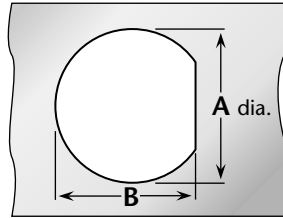

D-Hole

Figure	A	B
51	.755	.723
54	.630	.598
55	.630	.583
57	.557	.531
59	.505	.473
62	.442	.410
63	.407	.362
65	.380	.348
66	.319	.292
67	.255	.236
68	.195	.176

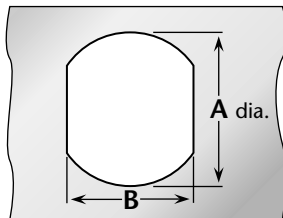

Double D-Hole

Figure	A	B
69	.755	.692
72	.630	.536
75	.380	.341
84	.319	.278

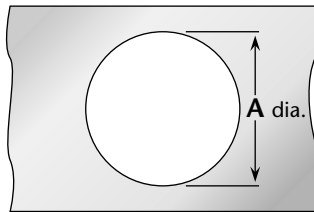

Round Hole

Figure	A
82	.255
89	.380

P.C. Board Drilling

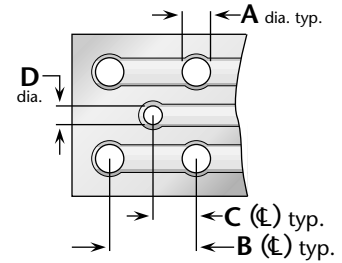

(PCB traces are shown for illustrative purpose only, and are not representative of actual circuitry.)

Coaxial connectors

Figure	A	B	C	D
PCB01	.067	.400	.200	.045
PCB02	.045	.500	.250	.045
PCB03	.067	.300	.150	.035
PCB05	.067	.200	.100	.055
PCB06	.067	.200	.100	.045

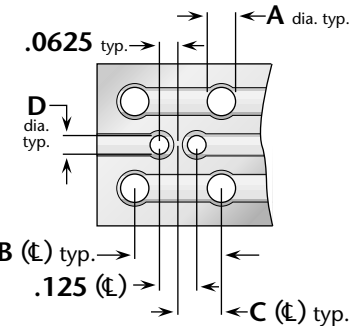

(PCB traces are shown for illustrative purpose only, and are not representative of actual circuitry.)

Twinax connectors

Figure	A	B	C	D
PCB04	.045	.500	.250	.045

Cable Group Finder			
Cable	Group	Cable	Group
RG-5, 5A, B	1A	RG-225	3C
RG-6, 6A	1B	RG-228A	20
RG-8, 8A	2A	RG-302	22
RG-9, 9A, B	3A	RG-303	23
RG-10	15	RG-304	24
RG-11, 11A	2B	RG-316	9A
RG-12	15	RG-316DS	10
RG-13A	3B	RG-393	4
RG-14A	16	RG-400	6A
RG-17A	17	RG-401	12
RG-18A	18	RG-402	13
RG-21, 21A	1A	RG-405	14
RG-22, 22A, B	28	M17/2	1B
RG-55, 55B	6B	M17/6	2B
RG-55A	6A	M17/15	28
RG-58, 58A, C	5	M17/28	5
RG-59, 59A, B	7A	M17/29	7A
RG-62, 62A, B, C	7A	M17/30	7A
RG-71, 71A, B	7B	M17/45	27
RG-108, 108A	27	M17/73	1A
RG-115A	19	M17/162	1A
RG-118A	20	M17/112	1C
RG-122	8A	M17/74	2A
RG-126	21	M17/75	3A
RG-141, 141A	5	M17/127	3C
RG-142, 142A	6A	M17/77	3B
RG-142B	6B	M17/60	6A
RG-143, 143A	1C	M18/84	6A
RG-174	9A	M17/128	6A
RG-174DS	10	M17/97	7A
RG-178, 178A, B	11	M17/54	8A
RG-179A, 179B	9B	M17/95	8B
RG-180, 180A, B	8B	M17/137	8B
RG-187, 187A	9B	M17/152	9A
RG-188, 188A	9A	M17/93	11
RG-195	8B	M17/129	12
RG-196, 196A	11	M17/130	13
RG-210	7A	M17/133	14
RG-212	1C	M17/78	16
RG-213	2A	M17/165	16
RG-214	3A	M17/176	30
RG-215	15	AT&T 735A	31
RG-217	16	Belden 8281	26
RG-218	17	Belden 9207	29
RG-219	18	Dearborn 6207	29
RG-222	1C	IBM 7362211	29
RG-223	6A		

Delta Cable Groups	
Group	Cables
1	1A RG-5, 5A, 5B, 21, 21A; M17/73, /162
	1B RG-6, 6A; M17/2
	1C RG-143, 143A, 212, 222; M17/73, /112, /162
2	2A RG-8, 8A, 213; M17/74
	2B RG-11, 11A; M17/6
3	3A RG-9, 9A, 9B, 214; M17/75
	3B RG-13A, 216; M17/77
	3C RG-225; M17/127
4	RG-393; M17/127
5	RG-58, 58A, 58C, 141, 141A; M17/28, /111
6	6A RG-55A, 142, 142A, 223, 400; M17/60, /84, /128
	6B RG-55, 55B, 142B; M17/60, /84
7	7A RG-59, 59A, 59B, 62, 62A, 62B, 62C, 210; M17/29, /30, /97
	7B RG-71, 71A, 71B; M17/90
8	8A RG-122; M17/54
	8B RG-180, 180A, 180B, 195; M17/95, /137
9	9A RG-174, 188, 188A, 316; M17/152
	9B RG-179A, 179B, 187, 187A; M17/94, /136
10	Double-Shielded RG-174, 316; M17/152
11	RG-178, 178A, 178B, 196, 196A; M17/93
12	.250" semi-rigid; RG-401; M17/129
13	.141" semi-rigid; RG-402; M17/130
14	.085" semi-rigid; RG-405; M17/133
15	RG-10, 12, 215; M17/6, /74
16	RG-14A, 217; M17/78, /165
17	RG-17A, 218
18	RG-18A, 219
19	RG-115A
20	RG-118A, 228A
21	RG-126
22	RG-302
23	RG-303
24	RG-304
25	Special 8X cable; contact factory for details.
26	Belden 8281
27	RG-108, 108A; M17/45
28	RG-22, 22A, 22B; M17/15
29	Belden 9207; Dearborn 6207; IBM 7362211
30	M17/176
31	AT&T 735A

Assembly Procedure A

- 1)** Trim cable jacket to dimension A. Slide backnut, washer, V-gasket, and braid clamp onto cable as shown. Cable jacket should bottom on step in braid clamp.

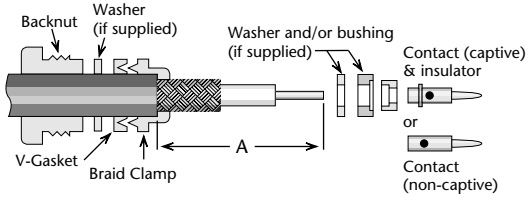

- 2)** Comb braid wires out straight and fold back over front shoulder of braid clamp (braid wires should not overlap one another after folding). Trim braid wires flush with step of braid clamp. Trim cable dielectric and center conductor to dimensions B and C.

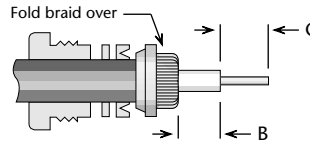

- 3)** If support insulator is provided for RG-62 or 71 cable, insert into hollow in dielectric. Assemble rear bushing or washer (if supplied), rear insulator (if captive contact) and contact, and solder contact to center conductor. Rear of contact should be flush with cable dielectric end. For right angle connectors with access cap, omit this step entirely.

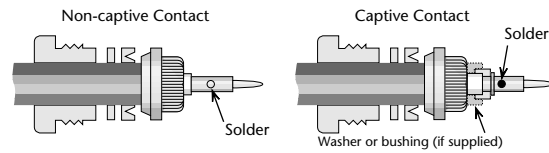

- 4)** Insert prepared cable and hardware into body and tighten backnut. For right angle connectors with access cap, solder center conductor into slot in contact and tighten access cap.

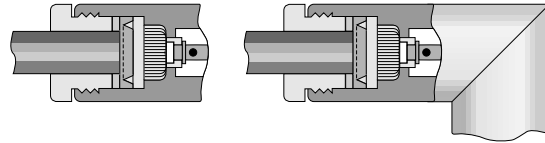

Trim Codes For Assembly Procedure A

Code	A	B	C	Code	A	B	C
A/01	.375 (3/8)	.047 (3/64)	.203 (13/64)	A/20	.375 (3/8)	.047 (3/64)	.172 (11/64)
A/02	.375 (3/8)	.109 (7/64)	.203 (13/64)	A/21	.500 (1/2)	.313 (5/16)	.172 (11/64)
A/03	.438 (7/16)	.250 (1/4)	.188 (3/16)	A/22	.375 (3/8)	.188 (3/16)	.141 (9/64)
A/04	.281 (9/32)	.047 (3/64)	.125 (1/8)	A/23	.438 (7/16)	.078 (5/64)	.172 (11/64)
A/05	.313 (5/16)	.125 (1/8)	.109 (7/64)	A/24	.500 (1/2)	.094 (3/32)	.141 (9/64)
A/06	.594 (19/32)	.391 (25/64)	.156 (5/32)	A/25	.438 (7/16)	.141 (9/64)	.172 (11/64)
A/07	.375 (3/8)	.047 (3/64)	.125 (1/8)	A/26	.625 (5/8)	.281 (9/32)	.250 (1/4)
A/08	.281 (9/32)	.109 (7/64)	.094 (3/32)	A/27	.688 (11/16)	.281 (9/32)	.125 (1/8)
A/09	.344 (11/32)	.109 (7/64)	.094 (3/32)	A/28	.656 (21/32)	.297 (19/64)	.250 (1/4)
A/10	.406 (13/32)	.109 (7/64)	.203 (13/64)	A/29	.688 (11/16)	.125 (1/8)	.313 (5/16)
A/11	.500 (1/2)	.281 (9/32)	.156 (5/32)	A/30	.688 (11/16)	.469 (15/32)	.156 (5/32)
A/12	.343	.040	.219	A/31	.700 (21/32)	.453 (29/64)	.250 (1/4)
A/13	.375 (3/8)	.125 (1/8)	.156 (5/32)	A/32	.313 (5/16)	.078 (5/64)	.188 (3/16)
A/14	.355	.090	.188 (3/16)	A/33	.250 (1/4)	.078 (5/64)	.094 (3/32)
A/15	.425	.094 (3/32)	.259	A/34	.250 (1/4)	.062 (1/16)	.109 (7/64)
A/16	.328 (21/64)	.094 (3/32)	.188 (3/16)	A/35	.837	.575	.150
A/17	.375 (3/8)	.109 (7/64)	.125 (1/8)	A/36	.450	.250	.150
A/18	.375 (3/8)	.062 (1/16)	.172 (11/64)	A/37	.281	.038	.188
A/19	.375 (3/8)	.188 (3/16)	.094 (3/32)	A/38	.281	.069	.156

Assembly Procedure B

- 1) Trim cable per chart. Slide crimp sleeve back onto cable.

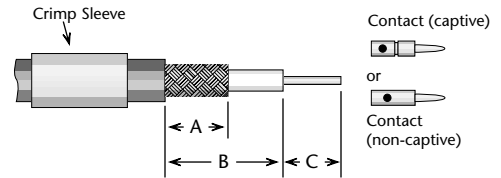

- 2) If support insulator is provided for RG-62 or 71 cable, insert into hollow in dielectric. Solder contact onto center conductor; back of contact flush with trimmed end of cable dielectric (omit this step for right angle connectors with access caps). Flare cut end of braid slightly by rotating dielectric.

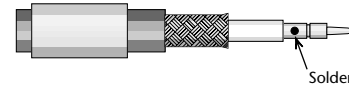

- 3) Insert cable/contact into rear of body, with all braid wires on outside of crimp tail.
- For captive contact connectors, push cable in until contact snaps into insulator.
 - For noncaptive contact connectors, push cable in until cable dielectric bottoms in connector.
 - For right angle or tee connectors with access caps, push cable in until end of braid touches connector body shoulder, and cable center conductor rests in contact slot.

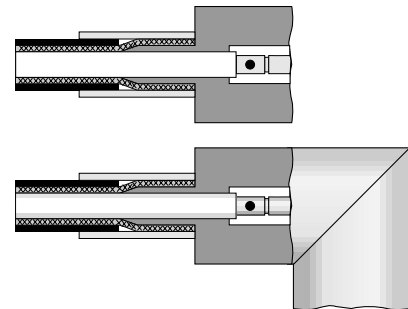

Trim excess braid wires even with shoulder of body. Slide crimp sleeve forward until flush with body and crimp (see page 176 for hex die sizes).

For right angle or tee connectors with access caps: Solder center conductor into contact slot, assemble insulator disc (if supplied), then press cap into body until seated or screw into place.

Trim Codes For Assembly Procedure B

Code	A	B	C	Code	A	B	C
B/01	.320	.470	.140	B/20	.250	.375	.156
B/02	.422	.578	.172	B/21	.425	.550	.156
B/03	.406	.500	.187	B/22	.375	.500	.156
B/04	.285	.505	.140	B/23	.281	.469	.125
B/05	.335	.460	.140	B/24	.250	.700	.109
B/06	.187	.437	.219	B/25	.343	.775	.125
B/07	.422	.610	.156	B/26	.343	.437	.109
B/08	.422	.562	.219	B/27	.313	.437	.187
B/09	.313	.610	.203	B/28	.219	.271	.078
B/10	.280	.436	.187	B/29	.200	.320	.060
B/11	.430	.542	.156	B/30	.500	.650	.219
B/12	.300	.434	.156	B/31	.350	.840	.150
B/13	.300	.447	.156	B/32	.175	.260	.095
B/14	.420	.645	.187	B/33	.195	.270	.045
B/15	.300	.420	.120	B/34	.150	.250	.105
B/16	.312	.609	.125	B/35	.195	.280	.170
B/17	.250	.500	.156	B/36	.150	.325	.090
B/18	.437	.562	.109	B/37	.195	.295	.075
B/19	.343	.437	.156	B/38	.150	.225	.095
				B/39	.250	.300	.135

Assembly Procedure C

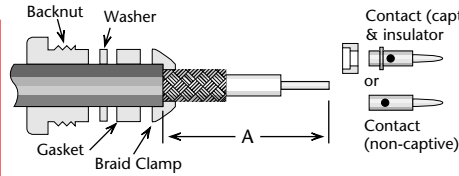

- 1)** Trim cable jacket to dimension A. Slide backnut, washer, gasket, and braid clamp onto cable as shown. Cable jacket should bottom on step in braid clamp.

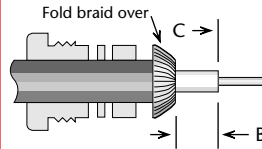

- 2)** Comb braid wires out straight and fold back over front shoulder of braid clamp (braid wires should not overlap one another after folding). Trim braid wires flush with edge of braid clamp. Trim cable dielectric and center conductor to dimensions B and C.

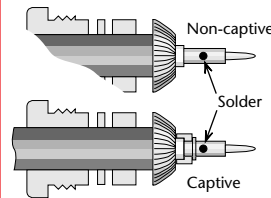

- 3)** If support insulator is provided for RG-62 or 71 cable, insert into hollow in dielectric. Assemble rear insulator (if captive contact) and contact, and solder contact to center conductor. Rear of contact should be flush with cable dielectric end.

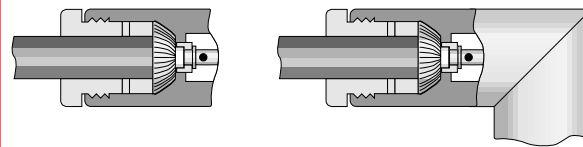

- 4)** Insert prepared cable and hardware into body and tighten backnut. For right angle connectors with access cap, solder cable center conductor to slot in contact and tighten access cap.

Trim Codes

Code	A	B	C
C/01	.656 (21/32)	.141 (9/64)	.250 (1/4)
C/02	.500 (1/2)	.125 (1/8)	.250 (1/4)
C/03	.450	.136	.187
C/04	.375 (3/8)	.109 (7/64)	.125 (1/8)
C/05	.375 (3/8)	.062 (1/16)	.250 (1/4)
C/06	.500 (1/2)	.188 (3/16)	.125 (1/8)
C/07	.575	.438	.094
C/08	.625 (5/8)	.141 (9/64)	.219 (7/32)

Assembly Procedure E

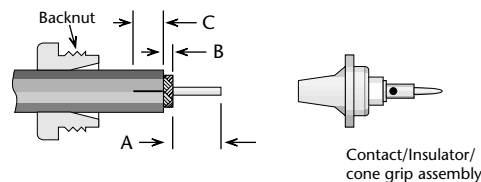

- 1)** Slide backnut onto cable as shown. Trim cable to dimensions A and B as shown. Slit jacket to dimension C in two places, 180° apart.

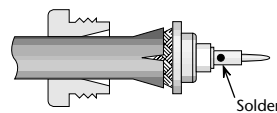

- 2)** Slide cone/insulator/contact assembly under braid until braid is flush with shoulder. Solder contact to center conductor.

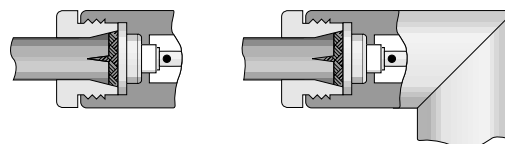

- 3)** Insert prepared cable and hardware into body; tighten assembly by holding nut stationary and turning body.

Trim Codes

Code	A	B	C
E/01	.250 (1/4)	.141 (9/64)	.313 (5/16)
E/02	.219 (7/32)	.063 (1/16)	.250 (1/4)
E/03	.250 (1/4)	.031 (1/32)	.250 (1/4)

Assembly Procedure F

Trim Codes		
Code	A	B
F/01	.250 (1/4)	.219 (7/32)
F/02	.250 (1/4)	.172 (11/64)
F/03	.188 (3/16)	.188 (3/16)
F/04	.109 (7/64)	.265 (17/64)
F/05	.156 (5/32)	.250 (1/4)
F/06	.219 (7/32)	.250 (1/4)
F/07	.156 (5/32)	.172 (11/64)
F/08	.109 (7/64)	.219 (7/32)

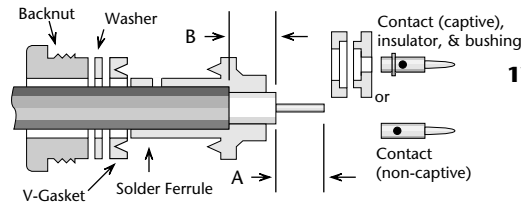

1) Trim cable per chart. Slide backnut, washer, v-gasket, and solder ferrule onto cable. Trimmed end of cable jacket should bottom on step in solder ferrule.

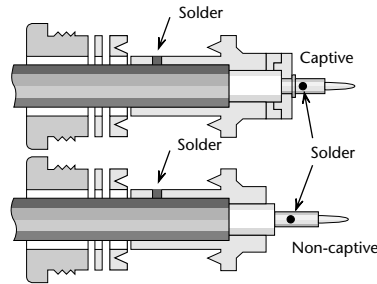

2) Solder ferrule to cable jacket as shown. Retrim cable dielectric to proper length if it has extruded from soldering heat. Slide bushing and rear insulator over cable dielectric if captive contact. Solder contact onto center conductor; back of contact flush with trimmed end of cable dielectric.

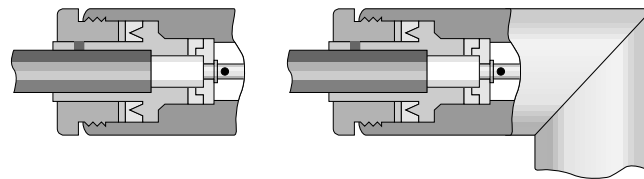

3) Insert prepared cable and hardware into body and tighten backnut.

Crimp Tools for Flexible Cable

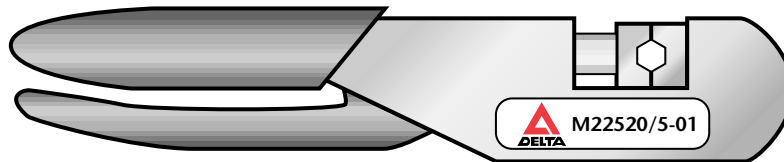

Frame only—P/N M22520/5-01—Use with interchangeable dies listed below.			
For Cable Group(s)	Hex Die Size	Die Set P/N	Closure
2, 3, 4	.429 hex, .400 wide	M22520/5-61	A
5, 6	.213 hex, .400 wide	M22520/5-19	B
7	.255 hex, .400 wide	M22520/5-19	A
9	.128 hex, .400 wide	M22520/5-35	B
10	.151 hex, .400 wide	M22520/5-37	B
11	.105 hex, .400 wide	M22520/5-33	B



Warranty

We warrant our parts to be free from defects in materials and workmanship for one year from date of purchase. During that time, we will repair or replace (at our option) any parts found to be defective.

This warranty does not apply to parts which have been modified, used in conditions exceeding Delta or military specifications, or disassembled. We will not, under any circumstances, be responsible for consequential or incidental damages or installation costs.

No other warranties apply, and no other liability may be assumed or extended by representatives or distributors.

Returns

Returns will be accepted only with a Return Authorization number issued by Delta, and are subject to inspection and acceptance upon arrival. Restocking charges will be determined prior to issuance of Return Authorization.

All claims for shortages must be made within 30 days of receipt by customer.

Ordering Information

Orders are subject to the terms and conditions on our order acknowledgement, which may only be modified by written agreement prior to sale. Order changes, cancellation, or termination will be accepted only with written approval from Delta Electronics Manufacturing.

Copyright, Trademarks, and Patents

Entire contents copyright 2003, Delta Electronics Manufacturing Corporation. Reproduction rights are hereby granted for, and specifically limited to, printing or other reproduction of drawings and specifications for inclusion in specification or source control drawings, or for purchasing procedures, by Delta customers only.

Heli-Grip, *PressMount*, and the New England Craftsmanship logo are trademarks. The Heli-Grip design is covered by U.S. and foreign patents.

Delta Electronics Manufacturing Corporation
416 Cabot Street, P.O. Box 53
Beverly, MA 01915
FSCM/CAGE 00795

Catalog # BNCpdf2003 1.0